

PRODUCT SPECIFICATION
QR044

Version:20191009v1

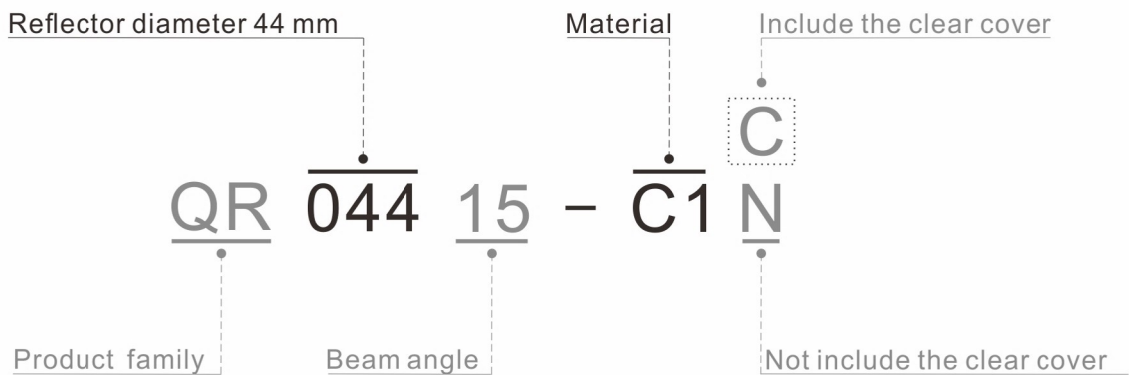

Basic parameters	-----	P2
Photometric data	-----	P3
Product dimension	-----	P4
Packing information	-----	P5

PRODUCT EXPLAIN

BASIC PARAMETERS

Model	QR044
Beam angle	15°/28°/40°/60°
Cover	Clear / Foggy
Temperature resistance	100°C
Plating/Color	Vacuum plating/Silver.
RoHS	Yes
Material	PC
Lens	No

SOURCE

Lumileds: 1202s / 1202HD

Luminus: CHM-9(AC00) Gen1 / CLM-9(AC00) Gen1 / CXM-9(AC00) Gen1 / CHM-6 Gen2
 CHM-9(AC10) Gen2 / CXM-9(AC00) Gen2 / CIM-9(AC30) Gen3 / CLM-9(AC30) Gen3
 CXM-9(AC30) Gen3 / CIM-9 Gen4 / CLM-9(AC40) Gen4 / CXM-9 Gen4

Nichia: NTCWT012B / NTCWS024B / NVNWS007Z / NJCWS024Z

Osram: S9

Seoul: SAWS0661A / SAWS1063A / SAW00661A / SAW01062A / SAW01063A / SAW80661A
 SAW90661A / SAW81062A / SAW91062A / SAW81063A / SAW91063A

Samsung: LC010C / LC003D / LC006D / LC009D / LC013D

Tridonic: SLE G7 9mm

HOLDERS

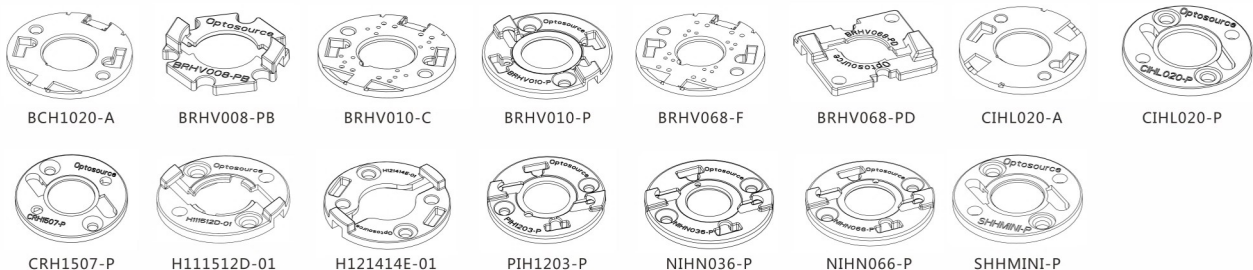

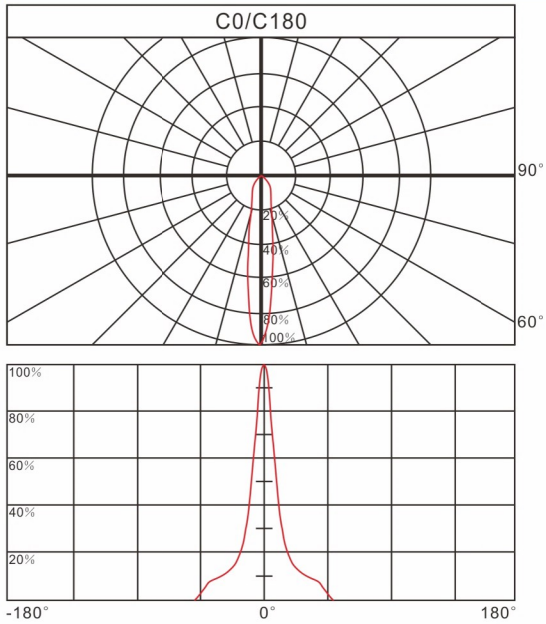
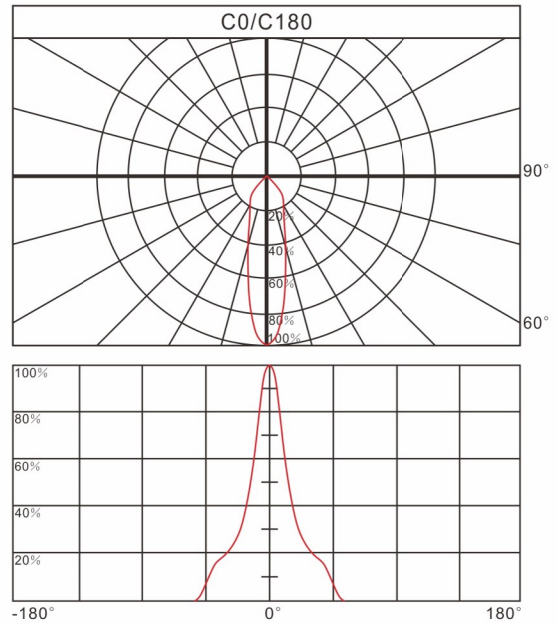
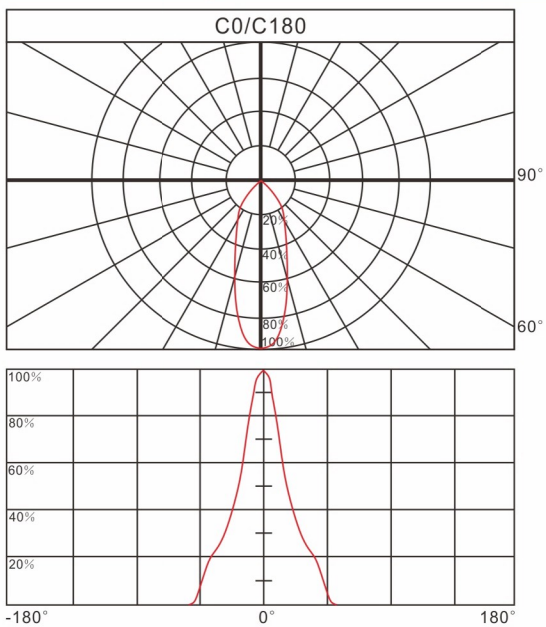
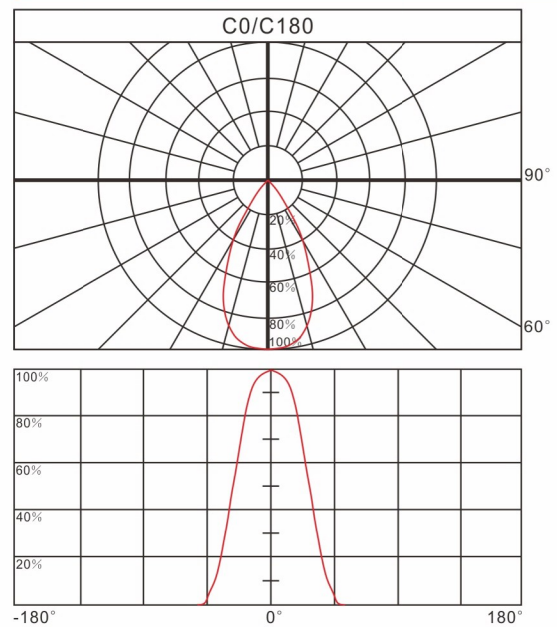
PHOTOMETRIC DATA
Relative intensity of QR04415

Relative intensity of QR04428

Relative intensity of QR04440

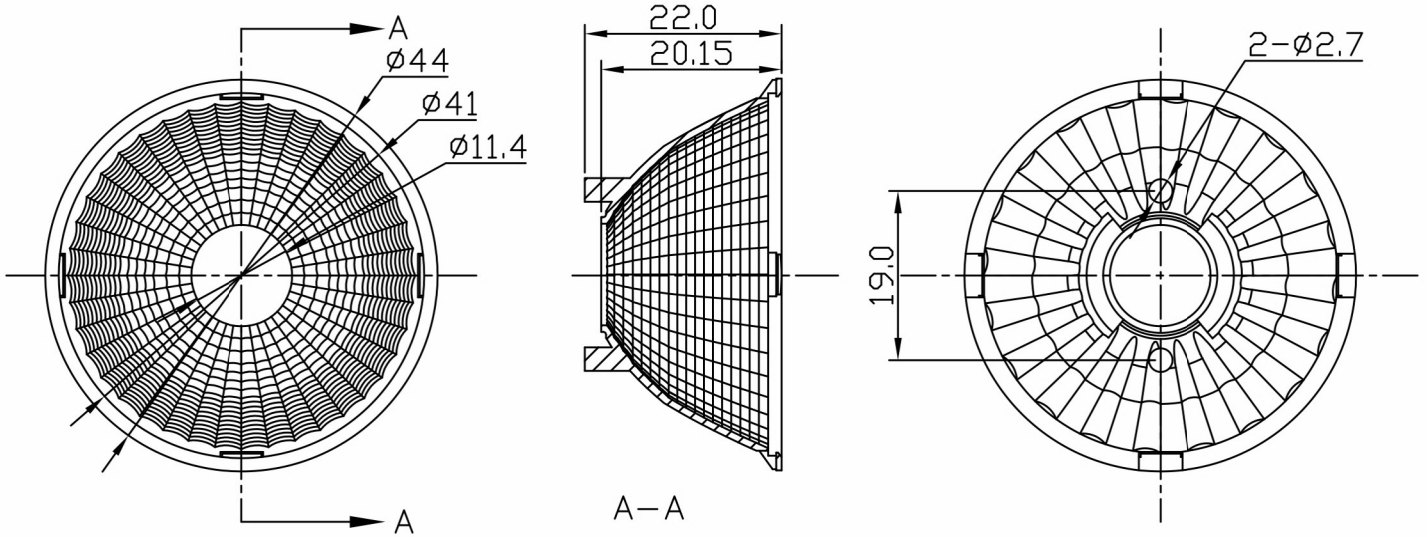
Relative intensity of QR04460

PRODUCT DIMENSION

Unit:mm



PACKING INFORMATION

Packing quantity	500pcs/10 layers / carton
Gross weight	3.7kgs
Carton measurement	515*290*270mm

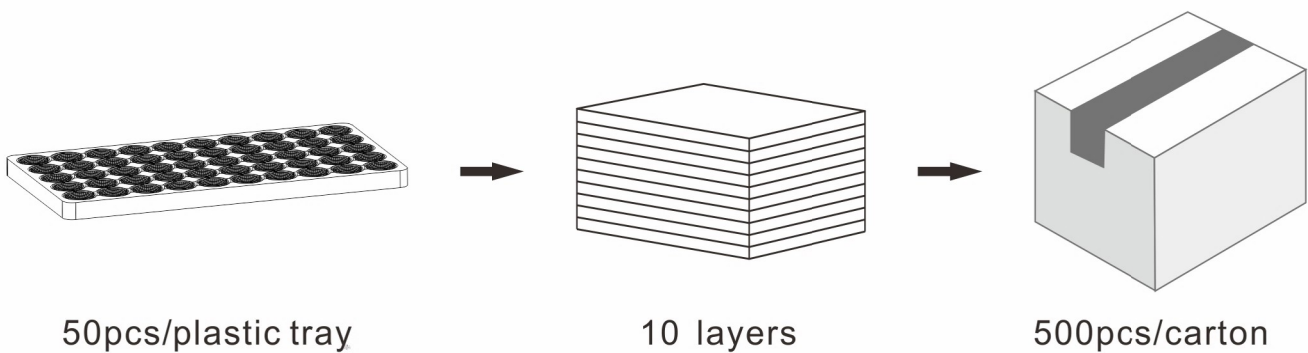

Note:

- * Above measurement and weight are measured manually.
If there have any difference, please refer to the actual product.

2/F, Building C1, No.73 Weiwu Road, Zengcheng, Guangzhou, China



Tel: +86 20 8266 0966
Fax: +86 20 8264 3119

E-mail: sales@opto-source.com
Website: www.opto-source.com