

PRODUCT SPECIFICATION
BR044

Version:20191009v1

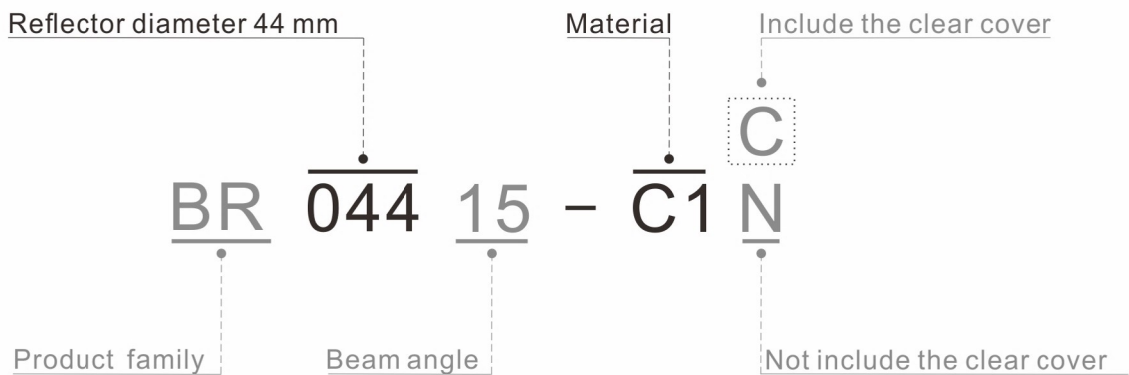

Basic parameters	-----	P2
Photometric data	-----	P3
Product dimension	-----	P4
Packing information	-----	P5

PRODUCT EXPLAIN

BASIC PARAMETERS

Model	BR044
Beam Angle	15°/28°/40°/60°
Cover	Clear / Foggy
Operating temperature (Tj)	≤85°C
Plating/Color	Vacuum plating/Silver
RoHS	Yes
Material	PC
Lens	No

SOURCE

Bridgelux: E6 / E8 / E10 / V8 Gen8 / V10 Gen8 / V8 Gen7 / V10 Gen7 / V6 Gen6 / V8 Gen6 / V10 Gen6
V6 HD / Vero 10 Gen6 / Vero 10 Gen7

HOLDERS

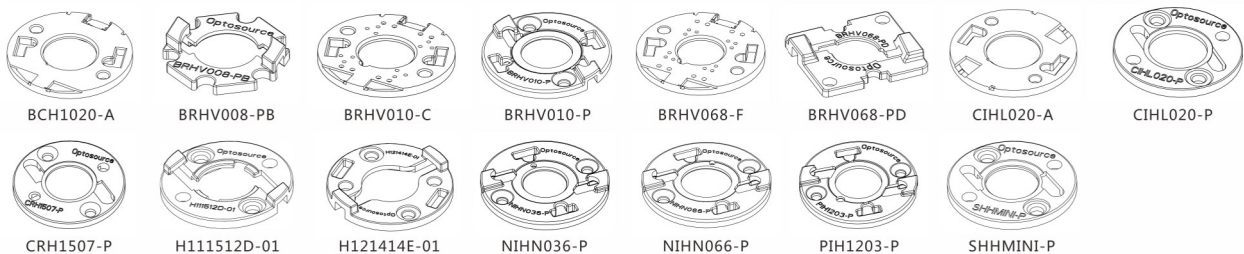

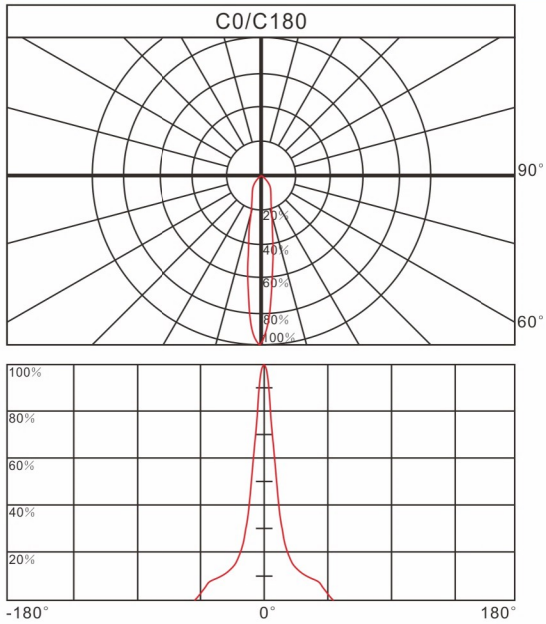
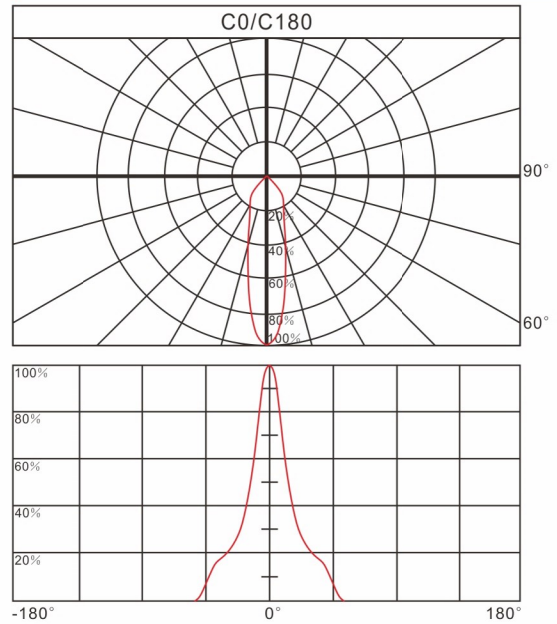
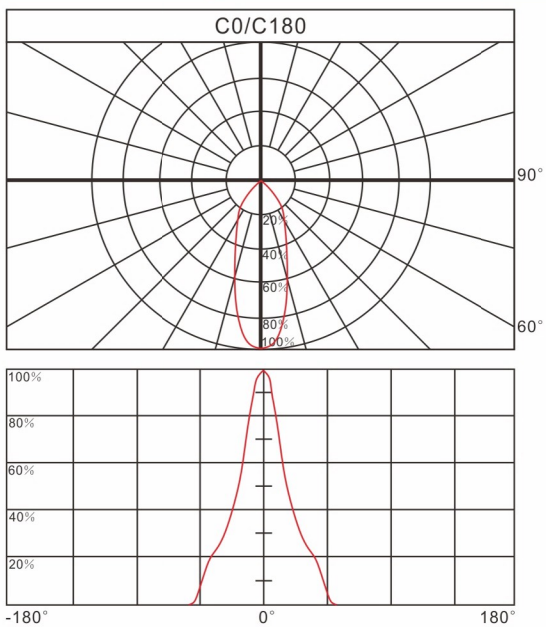
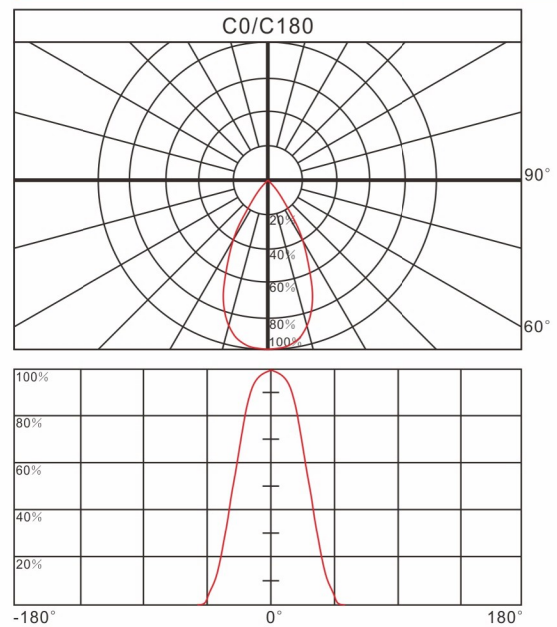
PHOTOMETRIC DATA
Relative intensity of BR04415

Relative intensity of BR04428

Relative intensity of BR04440

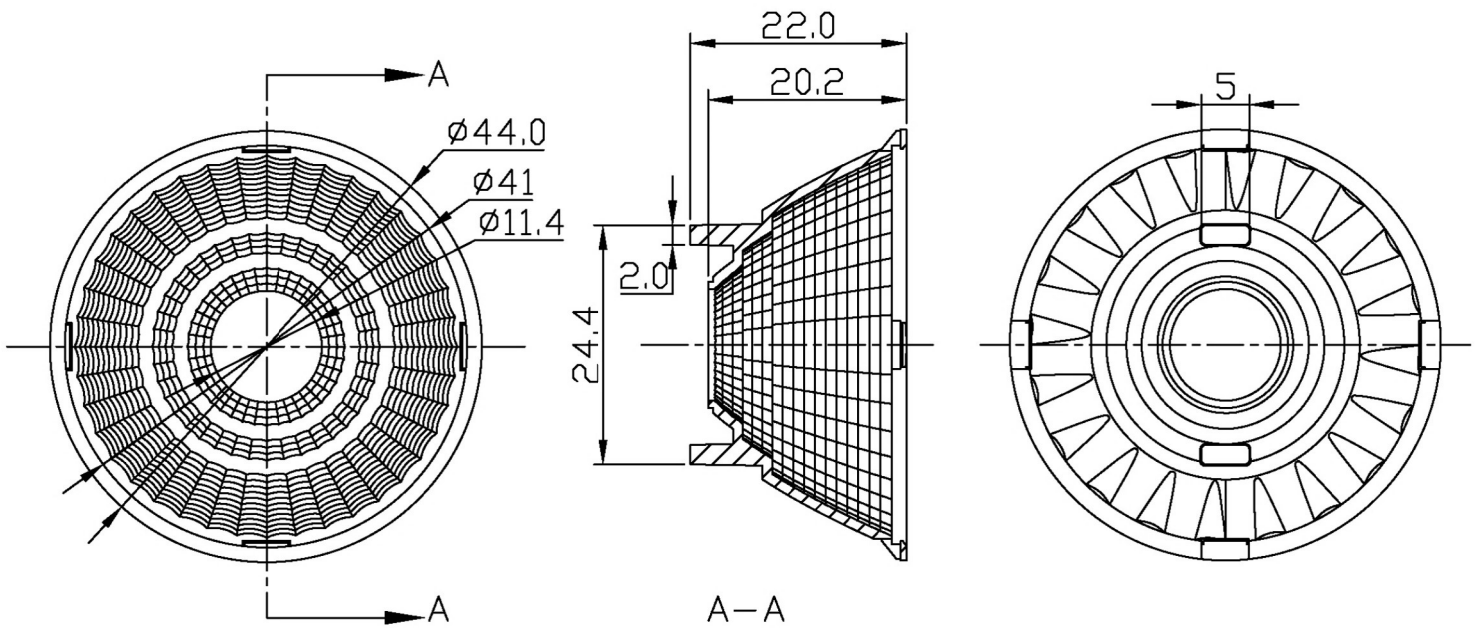
Relative intensity of BR04460

PRODUCT DIMENSION

Unit:mm



PACKING INFORMATION

Packing quantity	500pcs/10 layers / carton
Gross weight	3.3kgs
Carton measurement	515*290*270mm



50pcs/plastic tray

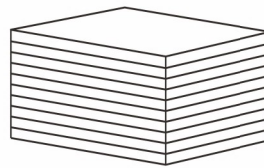

10 layers

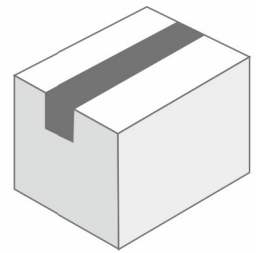

500pcs/carton

Note:

- * Above measurement and weight are measured manually.
If there have any difference, please refer to the actual product.

2/F, Building C1, No.73 Weiwu Road, Zengcheng, Guangzhou, China



Tel: +86 20 8266 0966
Fax: +86 20 8264 3119

E-mail: sales@opto-source.com
Website: www.opto-source.com