

PRODUCT SPECIFICATION
CI044

Version:20191009v1

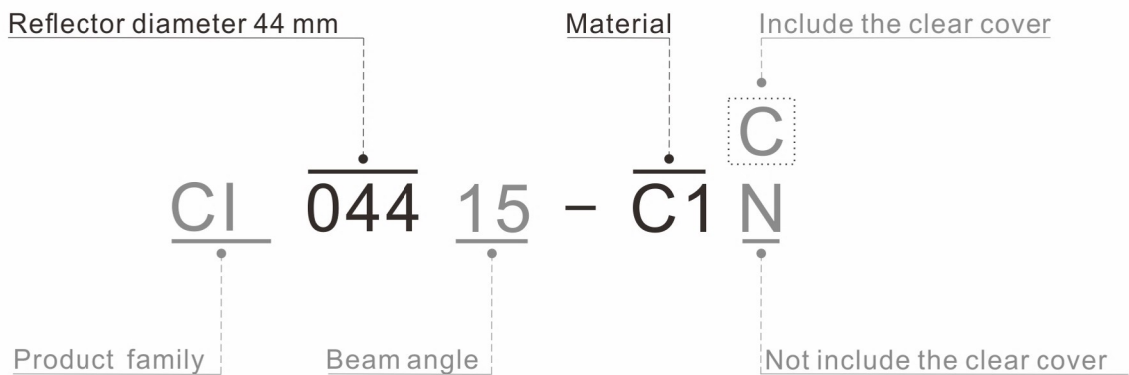

Basic parameters	-----	P2
Photometric data	-----	P3
Product dimension	-----	P4
Packing information	-----	P5

PRODUCT EXPLAIN

BASIC PARAMETERS

Model	CI044
Beam angle	15°/28°/40°/60°
Cover	Clear / Foggy
Operating temperature (Tj)	≤85°C
Plating/Color	Vacuum plating/Silver
RoHS	Yes
Material	PC
Lens	No

SOURCE

Citizen: CLU020x-120x / CLU701 / CLU702 / CLU7A2 / CLU7B2

HOLDERS



BCH1020-A



CIHL020-A



CIHL020-P

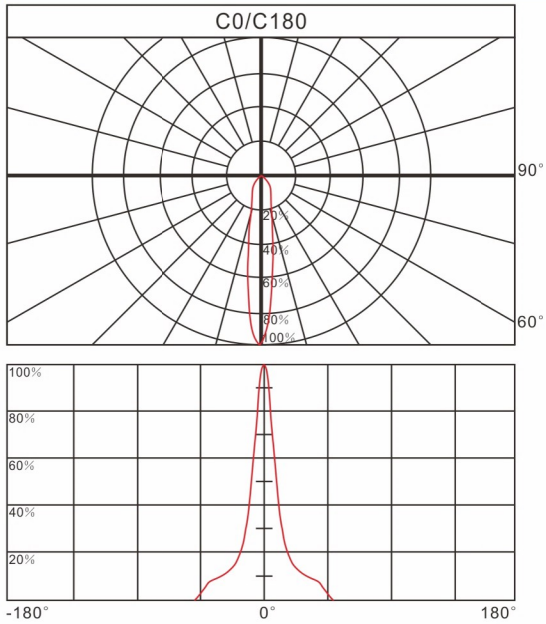
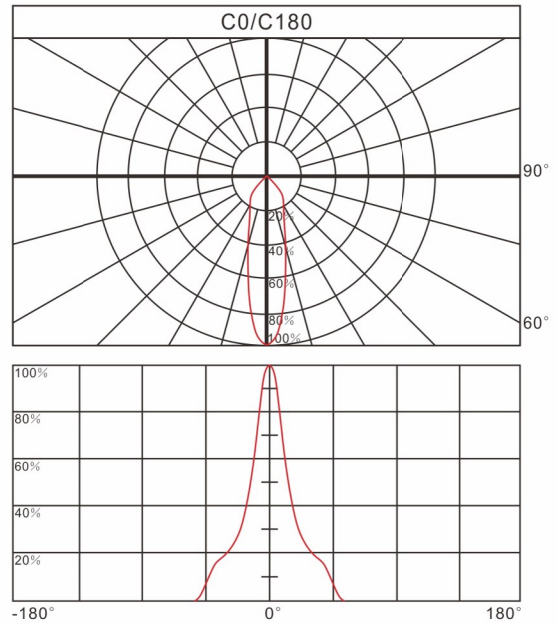
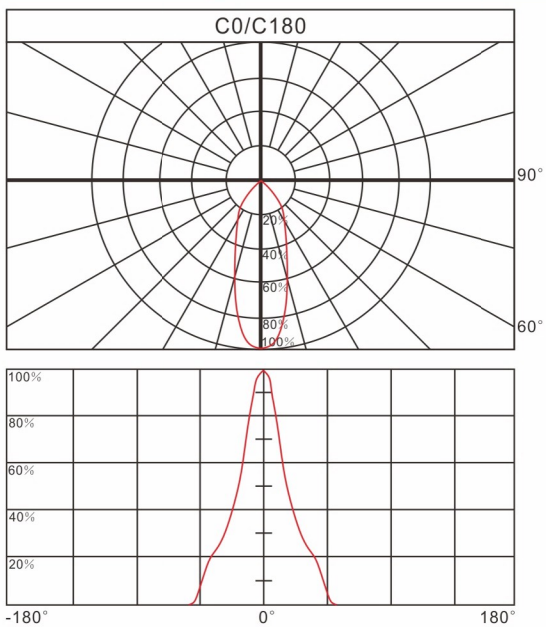
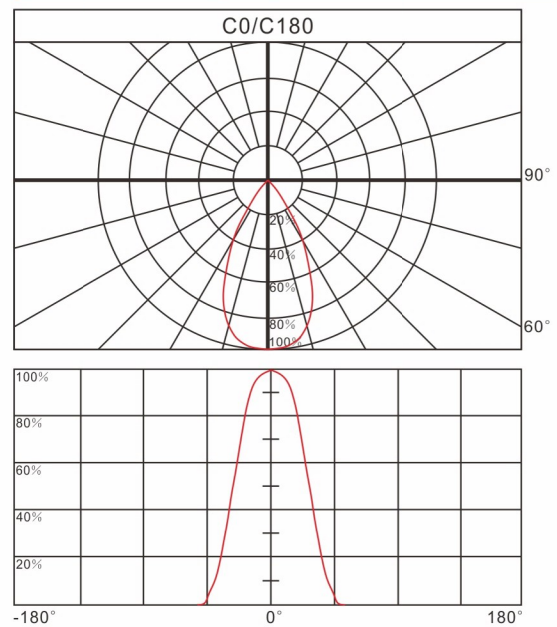

H121414E-01

PHOTOMETRIC DATA
Relative intensity of CI04415

Relative intensity of CI04428

Relative intensity of CI04440

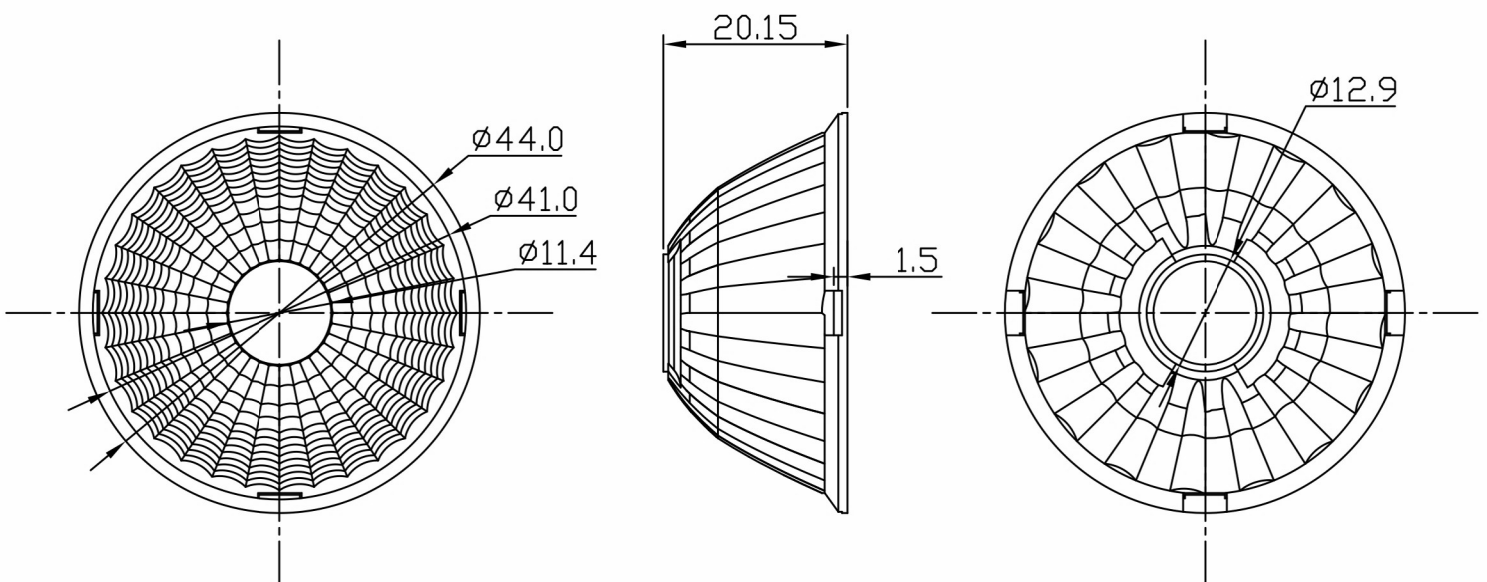
Relative intensity of CI04460

PRODUCT DIMENSION

Unit:mm



PACKING INFORMATION

Packing quantity	500pcs/10 layers / carton
Gross weight	4kgs
Carton measurement	515*290*270mm

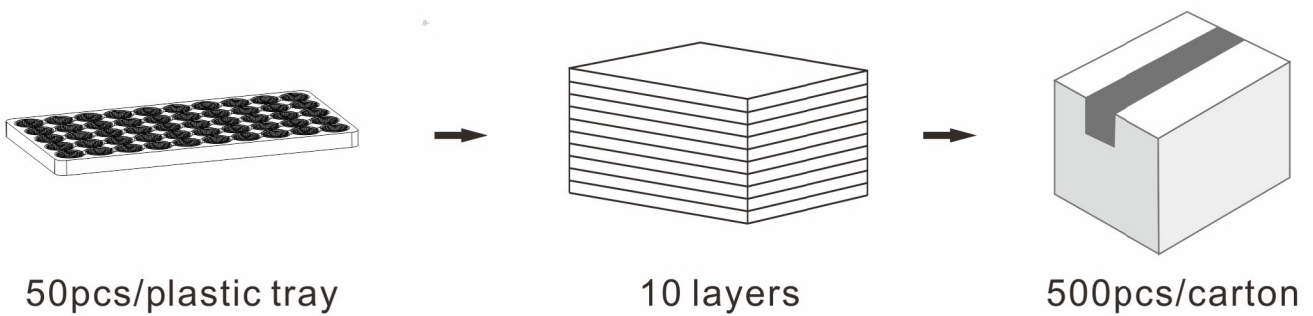

Note:

- * Above measurement and weight are measured manually.
If there have any difference, please refer to the actual product.

2/F, Building C1, No.73 Weiwu Road, Zengcheng, Guangzhou, China



Tel: +86 20 8266 0966
Fax: +86 20 8264 3119

E-mail: sales@opto-source.com
Website: www.opto-source.com