

PRODUCT SPECIFICATION
CR044

Version:20191009v1

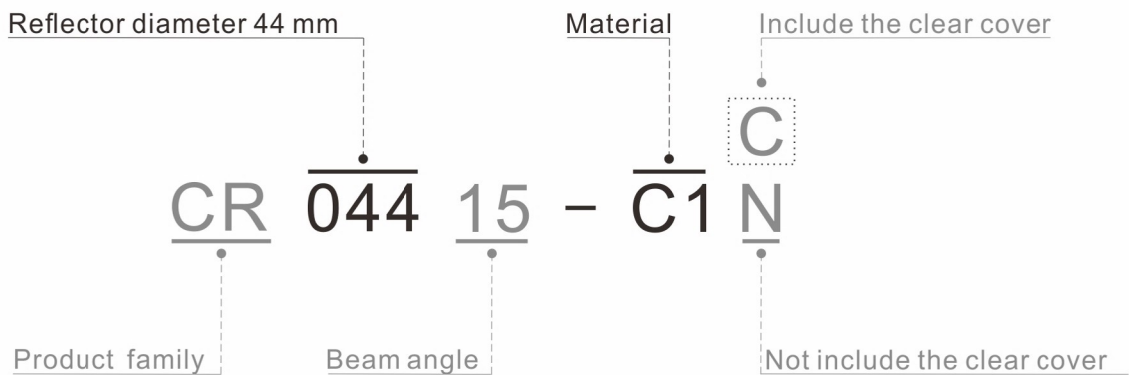

Basic parameters	-----	P2
Photometric data	-----	P3
Product dimension	-----	P4
Packing information	-----	P5

PRODUCT EXPLAIN

BASIC PARAMETERS

Model	CR044
Beam angle	15°/28°/40°/60°
Cover	Clear / Foggy
Operating temperature (Tj)	≤85°C
Plating/Color	Vacuum plating/Silver
RoHS	Yes
Material	PC
Lens	No

SOURCE

Cree: CXA1304 / CXB1304 / CXB1310 / CMA1306 / CXA15xx / CXB15xx / CMA1516 / CMT14xx

HOLDERS



CRH1507-P



H121414E-01



BRHV010-C

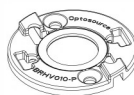

BRHV010-P



BRHV068-F

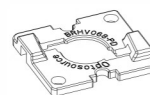

BRHV068-PD



BRHV008-PB



SHHMINI-P

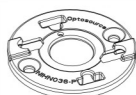

NIHN036-P

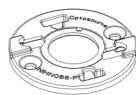

NIHN066-P

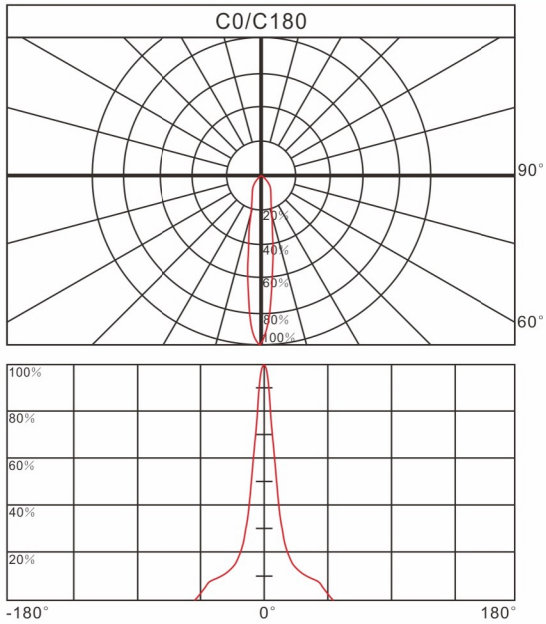
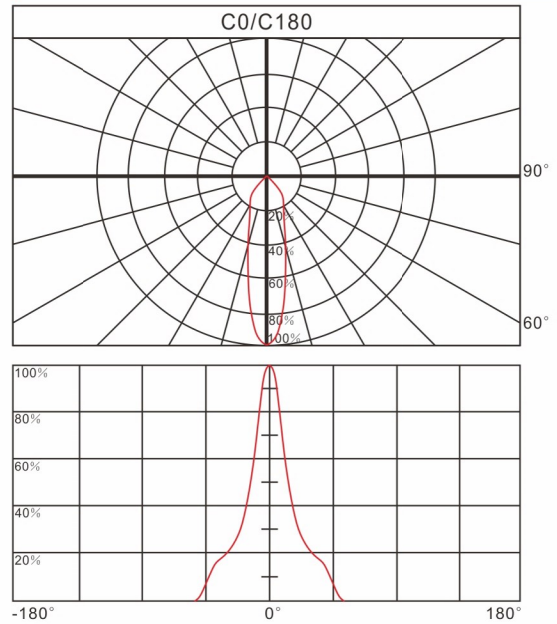
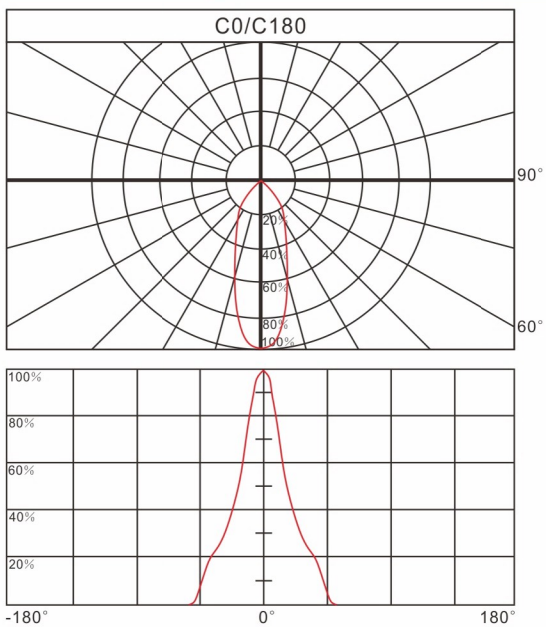
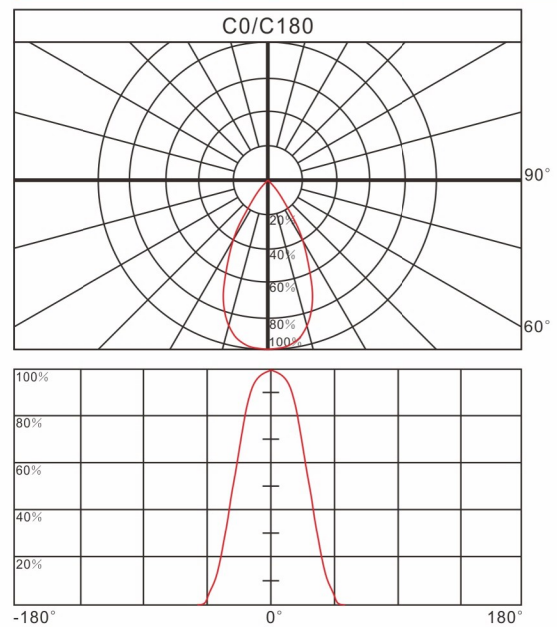

PIH1203-P

PHOTOMETRIC DATA
Relative intensity of CR04415

Relative intensity of CR04428

Relative intensity of CR04440

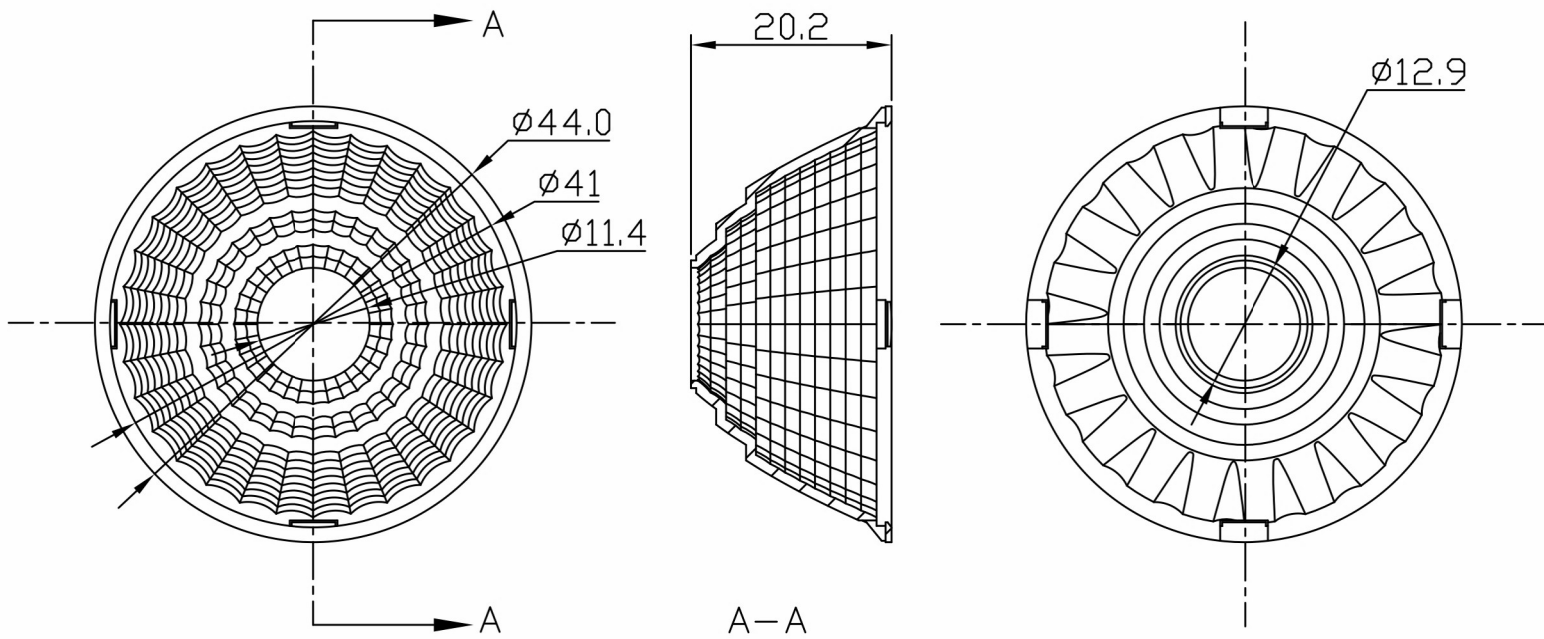
Relative intensity of CR04460

PRODUCT DIMENSION

Unit:mm



PACKING INFORMATION

Packing quantity	500pcs/10 layers / carton
Gross weight	3.8kgs
Carton measurement	515*290*270mm

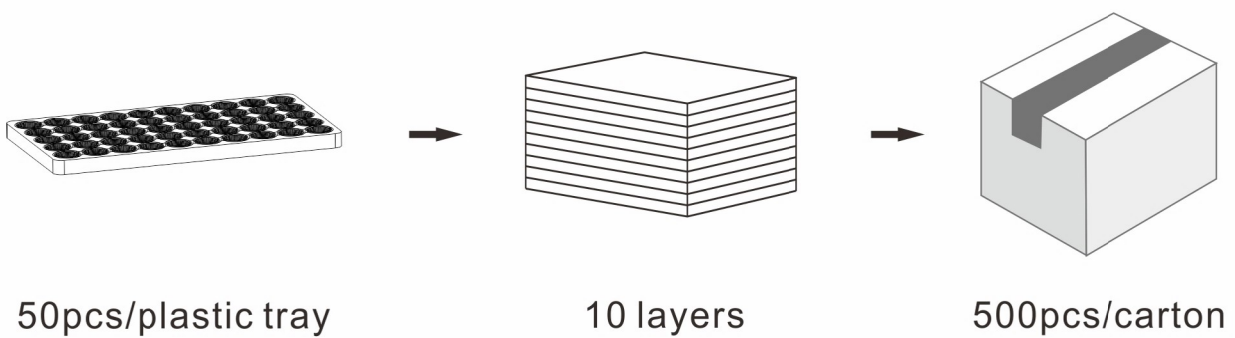

Note:

- * Above measurement and weight are measured manually.
If there have any difference, please refer to the actual product.

2/F, Building C1, No.73 Weiwu Road, Zengcheng, Guangzhou, China



Tel: +86 20 8266 0966
Fax: +86 20 8264 3119

E-mail: sales@opto-source.com
Website: www.opto-source.com