

**PRODUCT SPECIFICATION**
**CR080**

Version:20191009v1



Basic parameters	-----	P2
Photometric data	-----	P3
Product dimension	-----	P4
Packing information	-----	P5

**PRODUCT EXPLAIN**

---

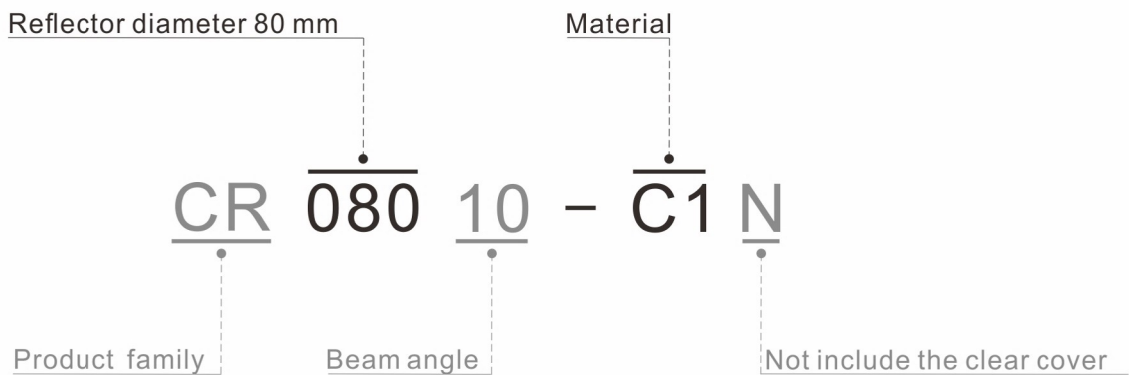

## BASIC PARAMETERS

Model	CR080
Beam angle	10°/24°/36°
Cover	No
Operating temperature (Tc)	≤70°C
Plating/Color	Vacuum plating/Silver
RoHS	Yes
Material	PC
Lens	No

## SOURCE

Bridgelux: E10 / V13 Gen8 / V15 Gen8 / V13 Gen7 / V9 HD

Cree: CXA1816 / CXA1820 / CXA1830 / CXB1816 / CXB1820 / CXB1830 / CMA18xx / CMT19xx

Citizen: CLU711 / CLU712

Lumileds: 1202 / 1203 / 1204 / 1205 / 1204HD / 1205HD

Luminus: CHM-9(AC00) Gen1 / CLM-9(AC00) Gen1 / CXM-9(AC00) Gen1 / CHM-6-XH20 Gen2

CHM-9(AC10)Gen2 / CXM-9(AC00) Gen2 / CIM-14(AC30) Gen3 / CLM-14(AC30) Gen3

CXM-14(AC30) Gen3 / CIM-14 Gen4 / CXM-14(AC40) Gen4 / CLM-14 Gen4 / CGM-14 Gen4

Nichia: NFCWL036B / NFCWL048B / NFCWL060B / NFCWL072B / NVEWL016Z / NVCWL024Z

Osram: S19

Samsung: LC020C / LC030C / LC040C / LC016D / LC019D / LC026D / LC033D

Seoul: SAWS1564A / SAWS1566A / SAW01564A / SAW01565A / SAW01566A / SAW81564A

SAW81565A / SAW81566A / SAW91564A / SAW91565A / SAW91566A

Tridonic: SLE G7 13mm / SLE G7 15mm

## HOLDERS



BCH1330-A



BRHV013-A



BRHV013-C



BRHV1518-A



CIHL030-B



CRH1830-A



LUH1114-A



LSHM9MI-A

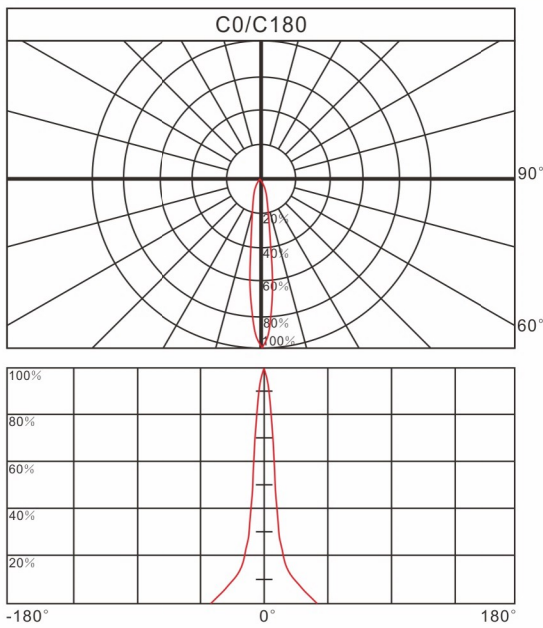
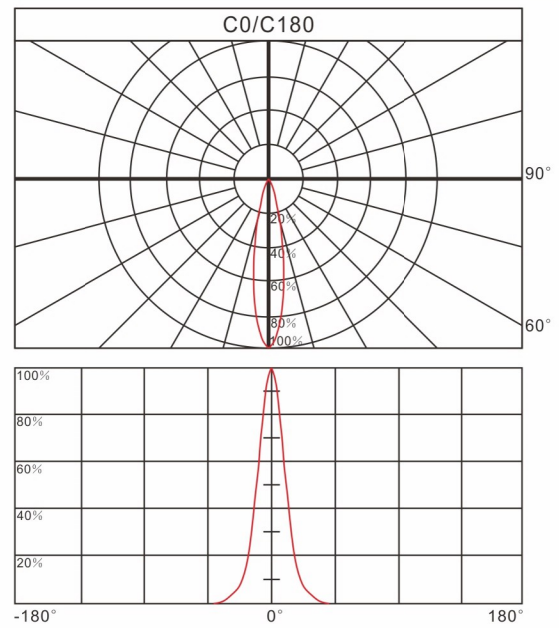
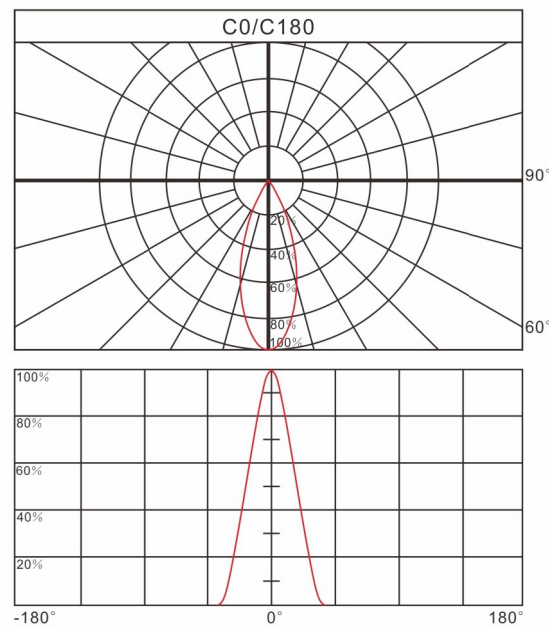

SHHMEGA-PC

**PHOTOMETRIC DATA**
**Relative intensity of CR08010**

**Relative intensity of CR08024**

**Relative intensity of CR08036**

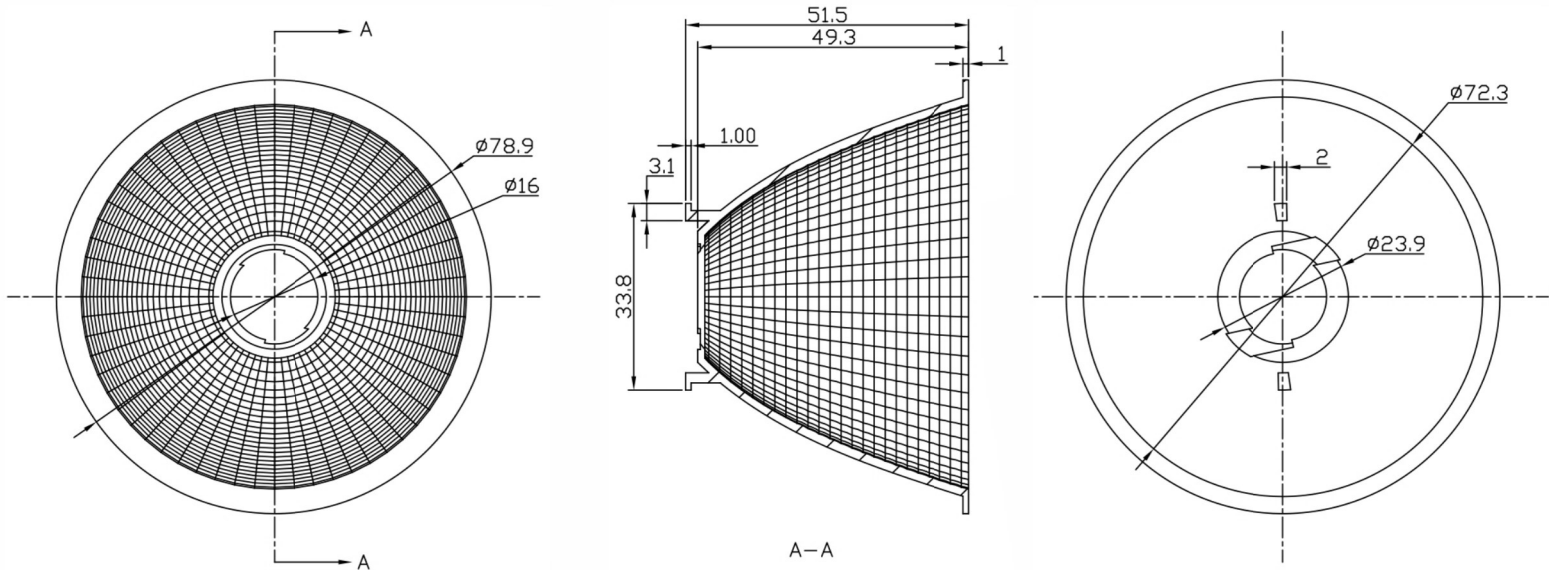
**PRODUCT DIMENSION**

Unit:mm



**PACKING INFORMATION**

Packing quantity	816pcs/12 layers / carton
Gross weight	20kgs
Carton measurement	650*400*680mm

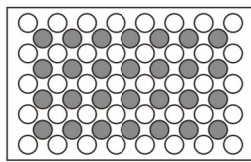

68pcs/layers

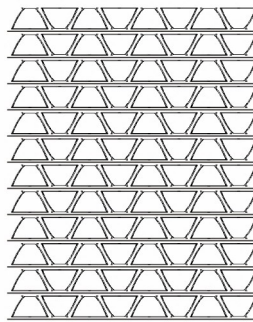

12 layers

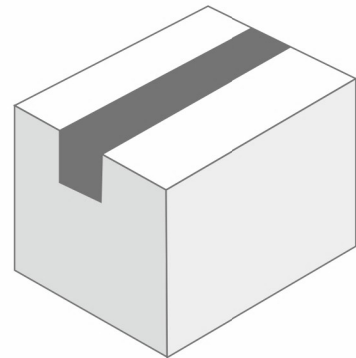

816pcs/carton

Note:

- \* Above measurement and weight are measured manually.  
If there have any difference, please refer to the actual product.

2/F, Building C1, No.73 Weiwu Road, Zengcheng, Guangzhou, China

 Tel: +86 20 8266 0966  
 Fax: +86 20 8264 3119

 E-mail: sales@opto-source.com  
 Website: www.opto-source.com