

PRODUCT SPECIFICATION
HG085

Version:20191009v1

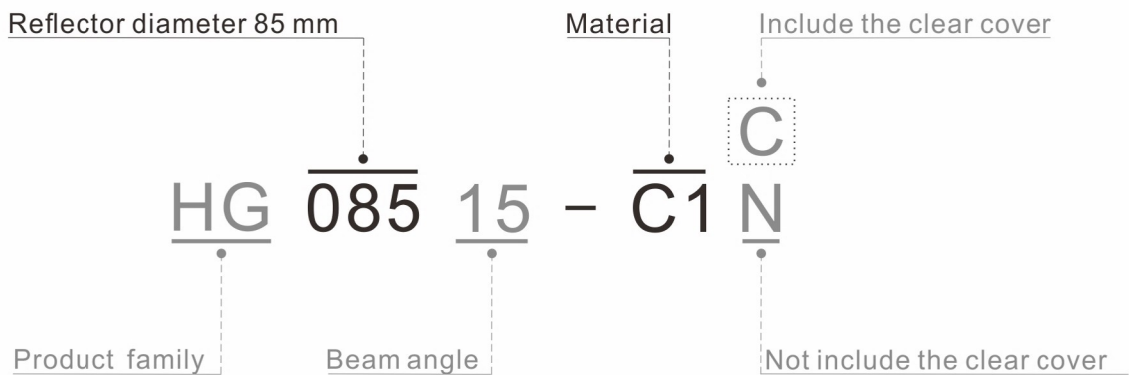

Basic parameters	-----	P2
Photometric data	-----	P3
Product dimension	-----	P4
Packing information	-----	P5

PRODUCT EXPLAIN

BASIC PARAMETERS

Model	HG085
Beam angle	15°/25°/38°
Cover	Clear
Operating temperature (Tc)	≤70°C
Plating/Color	Vacuum plating/Silver
RoHS	Yes
Material	PC
Lens	Yes

SOURCE

Bridgelux: E10 / V13 Gen8 / V15 Gen8 / V13 Gen7 / V18 Gen6 / V15 Gen6 / V9 HD
 Cree: CXA1816 / CXA1820 / CXA1830 / CXB1816 / CXB1820 / CXB1830 / CXA25xx / CXB25xx
 CMA18xx / CMT19xx / CMA2550
 Citizen: CLU03x-12xx / CLU711 / CLU712
 Lumileds: 1202 / 1203 / 1204 / 1205 / 1204HD / 1205HD / 1208
 Luminus: CHM-9(AC00) Gen1 / CLM-9(AC00) Gen1 / CXM-9(AC00) Gen1 / CHM-6-XH20 Gen2
 CHM-9(AC10)Gen2 / CXM-9(AC00) Gen2 / CIM-14(AC30) Gen3 / CLM-14(AC30) Gen3
 CXM-14(AC30) Gen3 / CIM-14 Gen4 / CXM-14(AC40) Gen4 / CLM-14 Gen4 / CGM-14 Gen4
 Nichia: NFCWL036B / NFCWL048B / NFCWL060B / NFCWL072B / NVEWL016Z / NVCWL024Z
 Osram: S19
 Samsung: LC020C / LC030C / LC040C / LC016D / LC019D / LC026D / LC033D
 Seoul: SAWS1564A / SAWS1566A / SAW01564A / SAW01565A / SAW01566A / SAW81564A
 SAW81565A / SAW81566A / SAW91564A / SAW91565A / SAW91566A
 Tridonic: SLE G7 13mm / SLE G7 15mm

HOLDERS

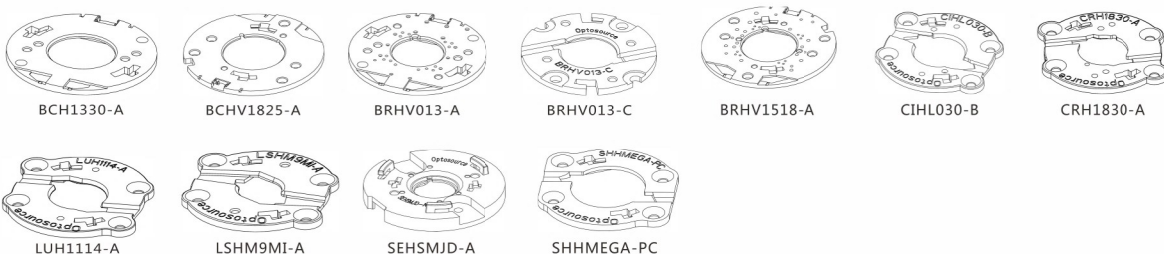

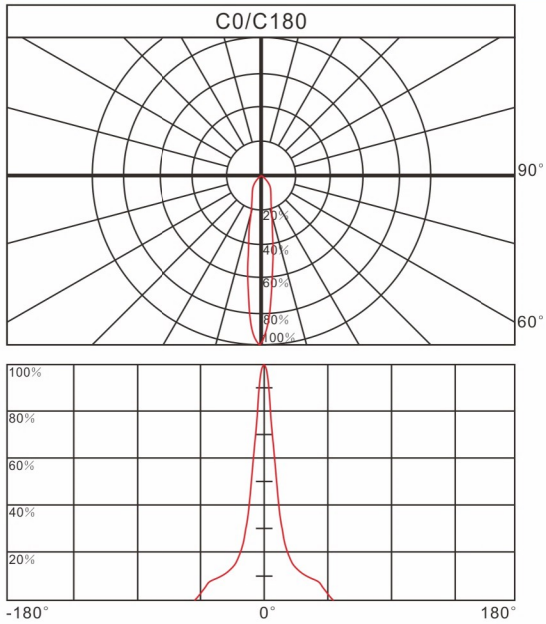
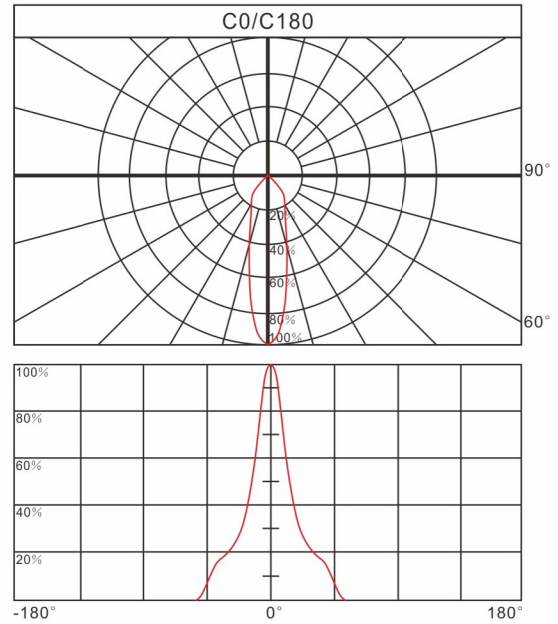
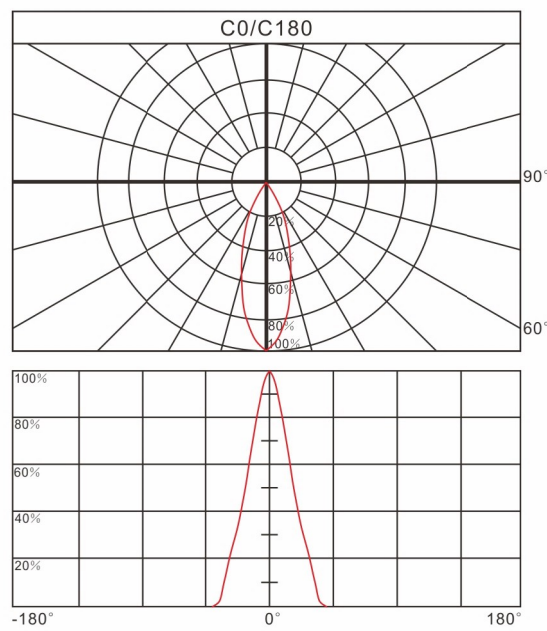
PHOTOMETRIC DATA
Relative intensity of HG08515

Relative intensity of HG08525

Relative intensity of HG08538

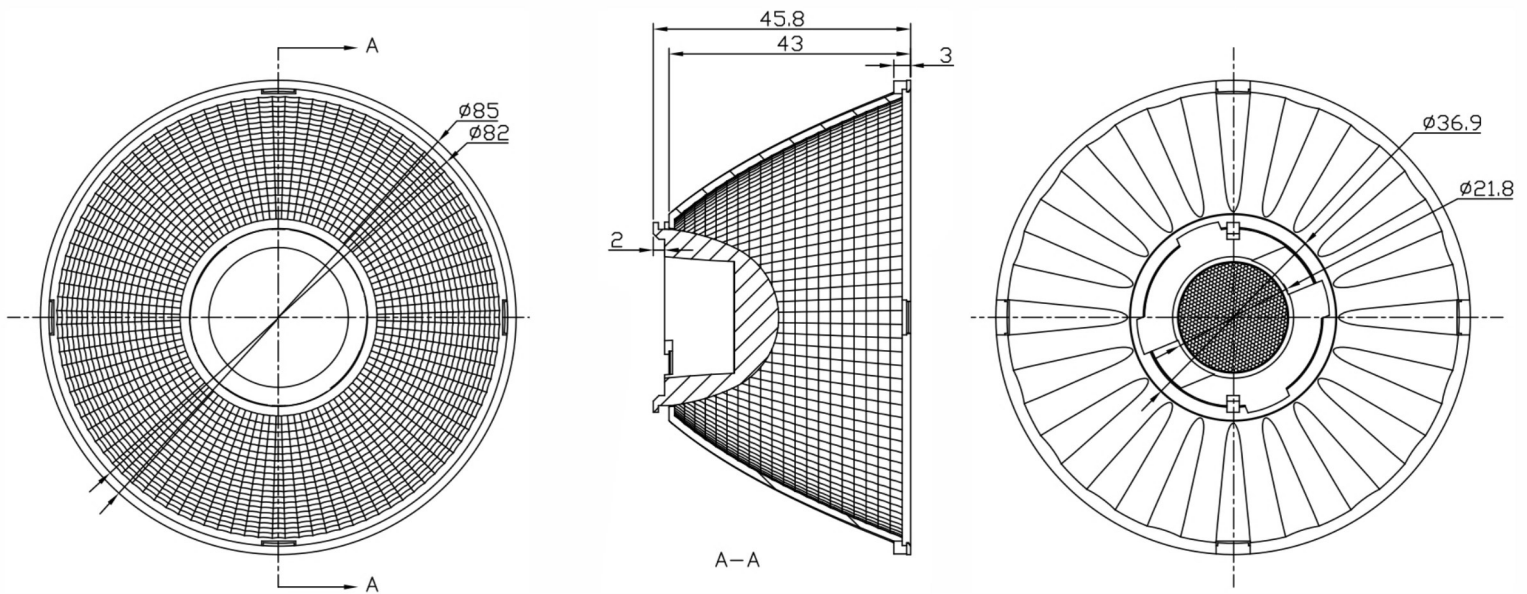
PRODUCT DIMENSION

Unit:mm



PACKING INFORMATION

Packing quantity	336pcs/14 layers / carton
Gross weight	14.1kgs
Carton measurement	650*400*680mm

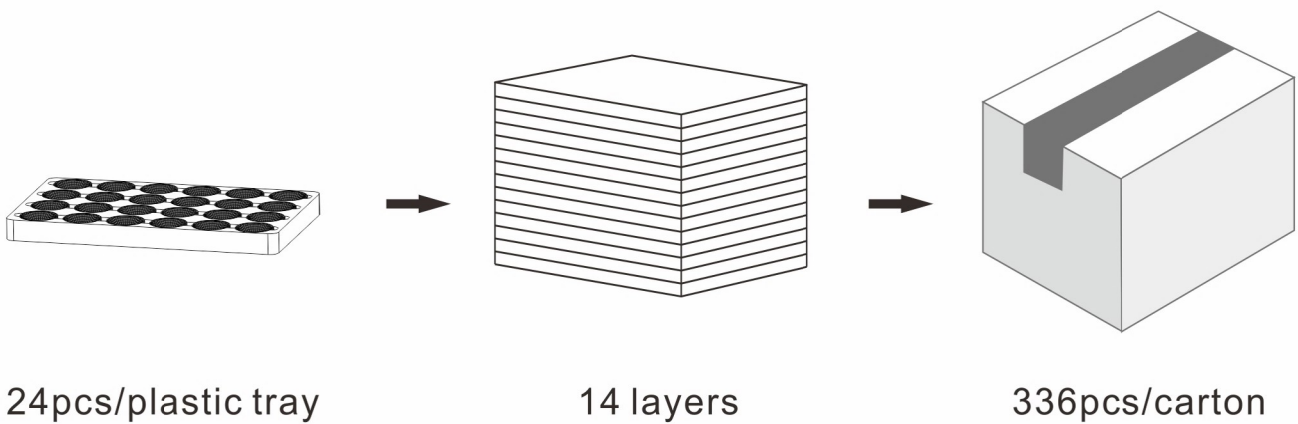

Note:

- * Above measurement and weight are measured manually.
If there have any difference, please refer to the actual product.

2/F, Building C1, No.73 Weiwu Road, Zengcheng, Guangzhou, China



Tel: +86 20 8266 0966
Fax: +86 20 8264 3119

E-mail: sales@opto-source.com
Website: www.opto-source.com