

PRODUCT SPECIFICATION
OP050

Version:20191009v1

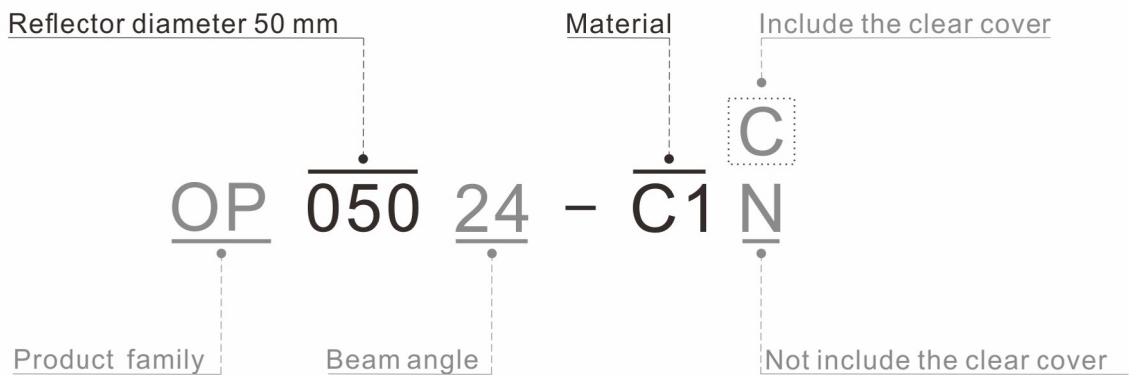

Basic parameters	-----	P2
Photometric data	-----	P3
Product dimension	-----	P4
Packing information	-----	P5

PRODUCT EXPLAIN

BASIC PARAMETERS

Model	OP050
Beam angle	24°/40°/60°
Cover	Clear / Foggy
Operating temperature (Tc)	≤70°C
Plating/Color	Vacuum plating/Silver
RoHS	Yes
Material	PC
Lens	Yes

SOURCE

Bridgelux: E6 / E8 / E10 / V8 Gen8 / V10 Gen8 / V8 Gen7 / V10 Gen7 / V6 Gen6 / V8 Gen6

Cree: CXA15xx / CXB15xx

Citizen: CLU02x-120x / CLU7A2 / CLU7B2 / CLU701 / CLU702

Luminus: CHM-9(AC00) Gen1 / CLM-9(AC00) Gen1 / CXM-9(AC00) Gen1 / CHM-6-XH20 Gen2
 CHM-9(AC10)Gen2 / CXM-9(AC00) Gen2 / CIM-9(AC30) Gen3 / CLM-9(AC30) Gen3
 CXM-9(AC30) Gen3 / CIM-9 Gen4 / CLM-9(AC40) Gen4 / CXM-9 Gen4

Osram: S9

Samsung: LC010C / LC003D / LC006D / LC009D / LC013D

Tridonic: SLE G7 9mm

HOLDERS

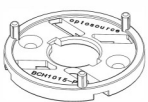

BCH1015-P

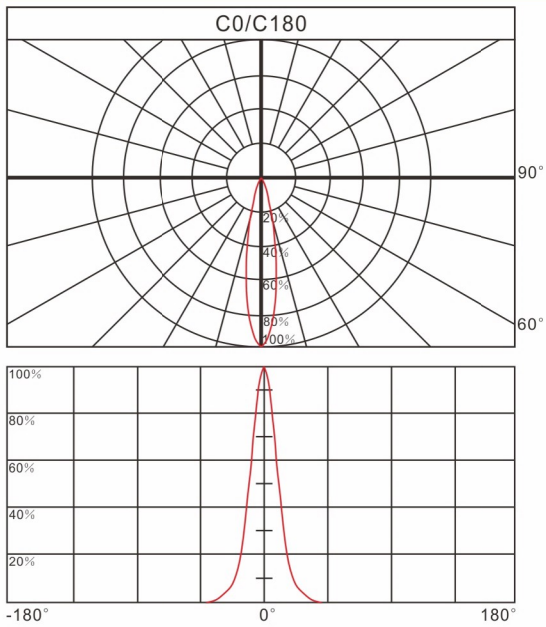
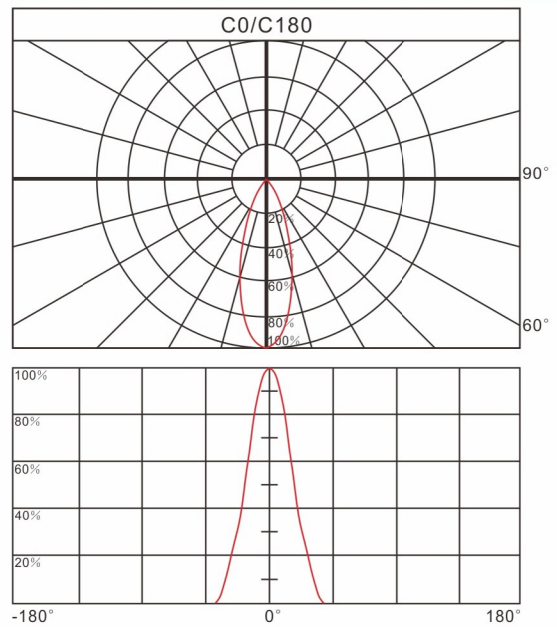
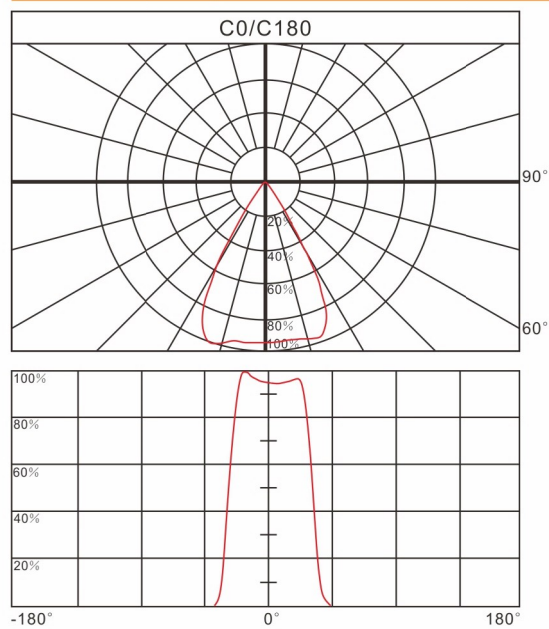

BCH6813-P

PHOTOMETRIC DATA
Relative intensity of OP05024

Relative intensity of OP05040

Relative intensity of OP05060

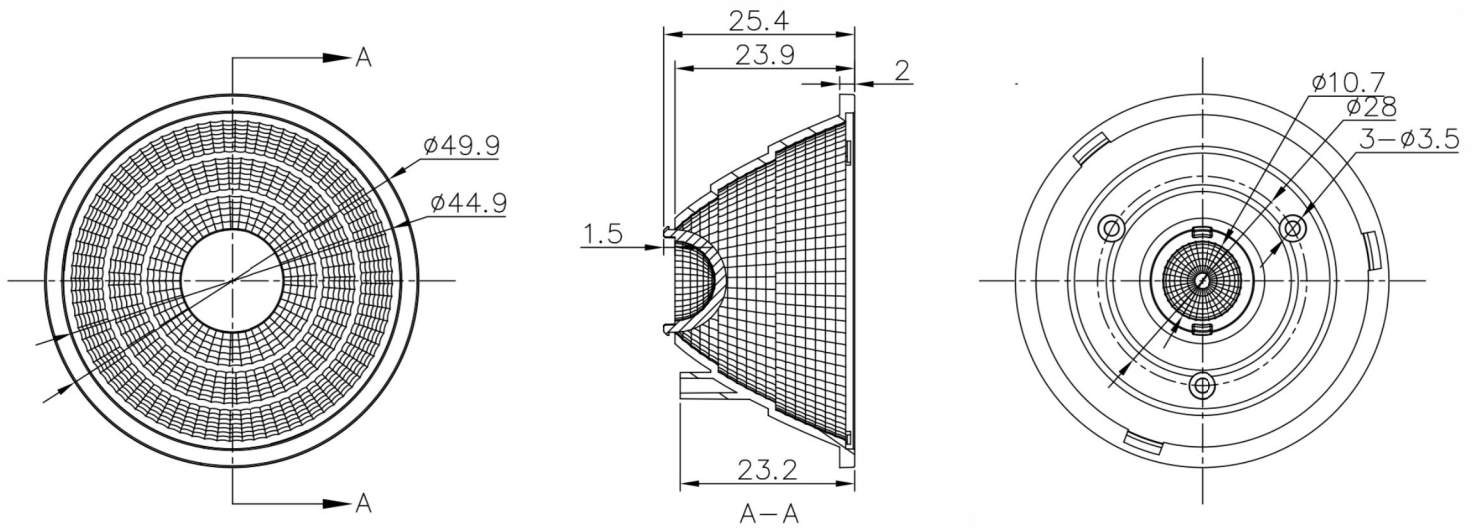
PRODUCT DIMENSION

Unit:mm



PACKING INFORMATION

Packing quantity	500pcs/10 layers / carton
Gross weight	6kgs
Carton measurement	560*345*440mm

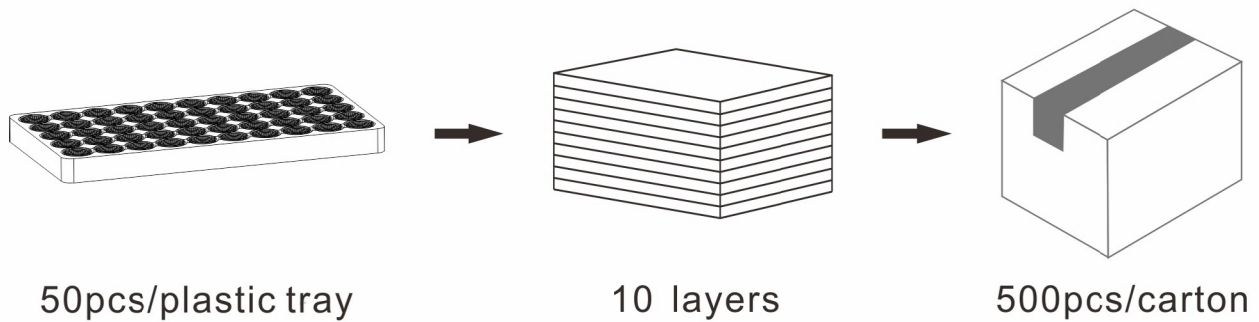

Note:

- * Above measurement and weight are measured manually.
If there have any difference, please refer to the actual product.

2/F, Building C1, No.73 Weiwu Road, Zengcheng, Guangzhou, China



Tel: +86 20 8266 0966
Fax: +86 20 8264 3119

E-mail: sales@opto-source.com
Website: www.opto-source.com