

PRODUCT SPECIFICATION
QR075

Version:20191009v1

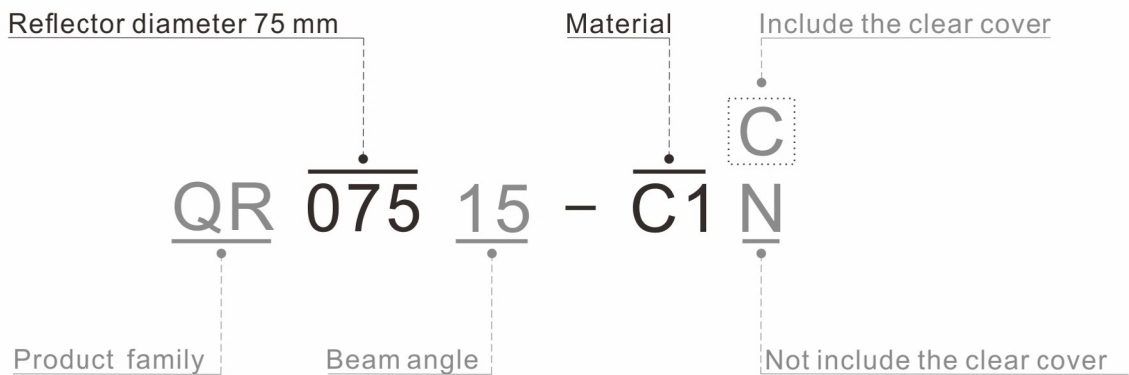

Basic parameters	-----	P2
Photometric data	-----	P3
Product dimension	-----	P4
Packing information	-----	P5

PRODUCT EXPLAIN

BASIC PARAMETERS

Model	QR075
Beam angle	15°/30°/32°/38°
Cover	Clear / Foggy
Operating temperature (Tc)	≤70°C
Plating/Color	Vacuum plating/Silver
RoHS	Yes
Material	PC
Lens	No

SOURCE

Cree: CXA1816 / CXA1820 / CXB1816 / CXB1820 / CXA25xx / CXB25xx / CMA18xx / CMT19xx
CMA2550

Citizen: CLU03x-12xx / CLU711 / CLU712

Lumileds: 1202 / 1203 / 1204 / 1205 / 1204HD / 1205HD / 1208

Luminus: CHM-9(AC00) Gen1 / CLM-9(AC00) Gen1 / CXM-9(AC00) Gen1 / CHM-6-XH20 Gen2
CHM-9(AC10)Gen2 / CXM-9(AC00) Gen2 / CIM-14(AC30) Gen3 / CLM-14(AC30) Gen3
CXM-14(AC30) Gen3 / CIM-14 Gen4 / CXM-14(AC40) Gen4 / CLM-14 Gen4 / CGM-14 Gen4

Nichia: NFCWL036B / NFCWL048B / NFCWL060B / NFCWL072B / NVEWL016Z / NVCWL024Z

Osram: S19

Samsung: LC020C / LC030C / LC040C / LC016D / LC019D / LC026D / LC033D

Seoul: SAWS1564A / SAWS1566A / SAW01564A / SAW01565A / SAW01566A / SAW81564A
SAW81565A / SAW81566A / SAW91564A / SAW91565A / SAW91566A

Tridonic: SLE G7 13mm / SLE G7 15mm

HOLDERS

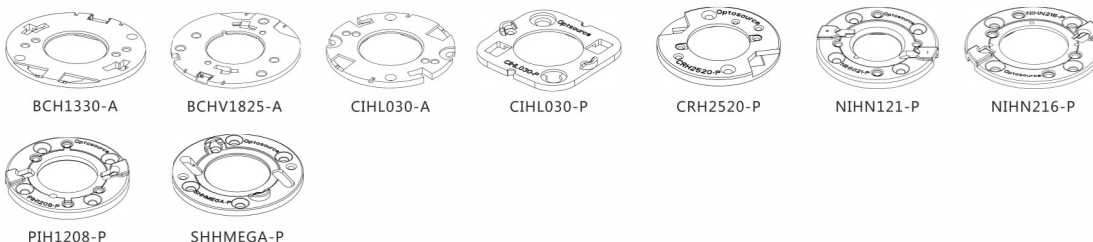

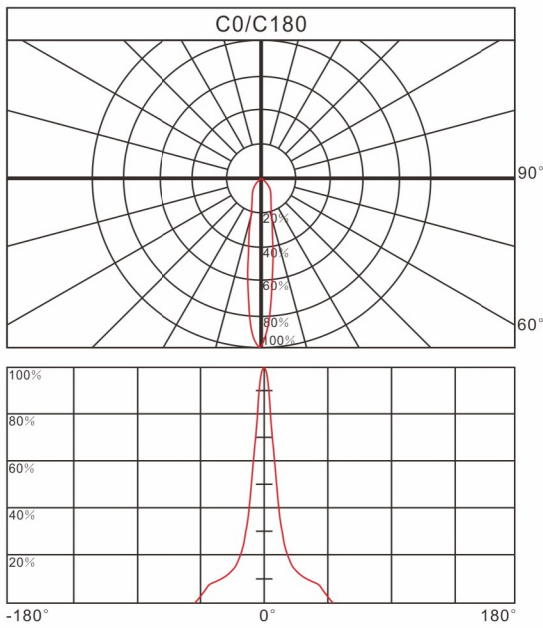
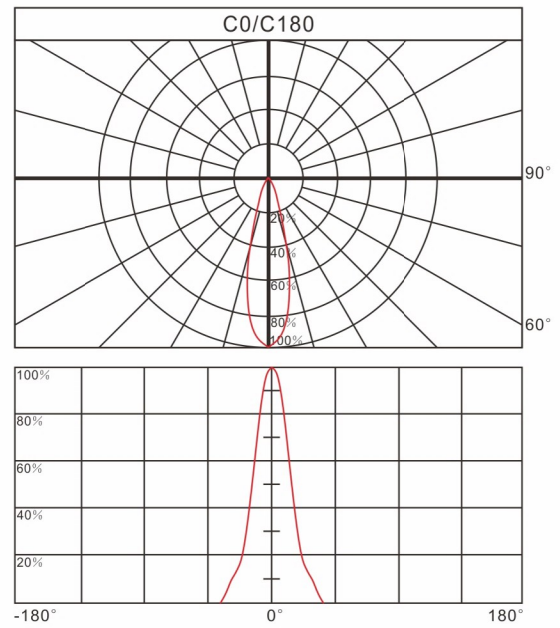
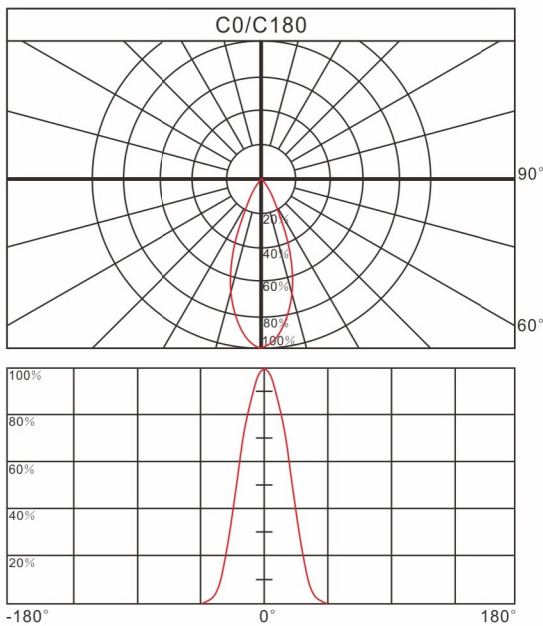
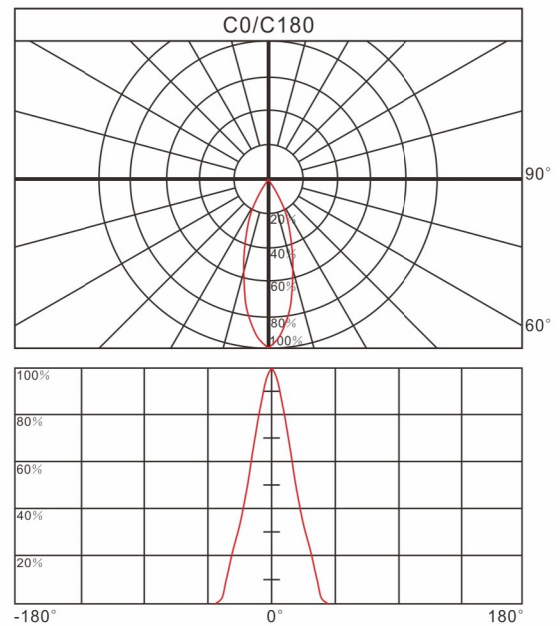
PHOTOMETRIC DATA
Relative intensity of QR07515

Relative intensity of QR07530

Relative intensity of QR07532

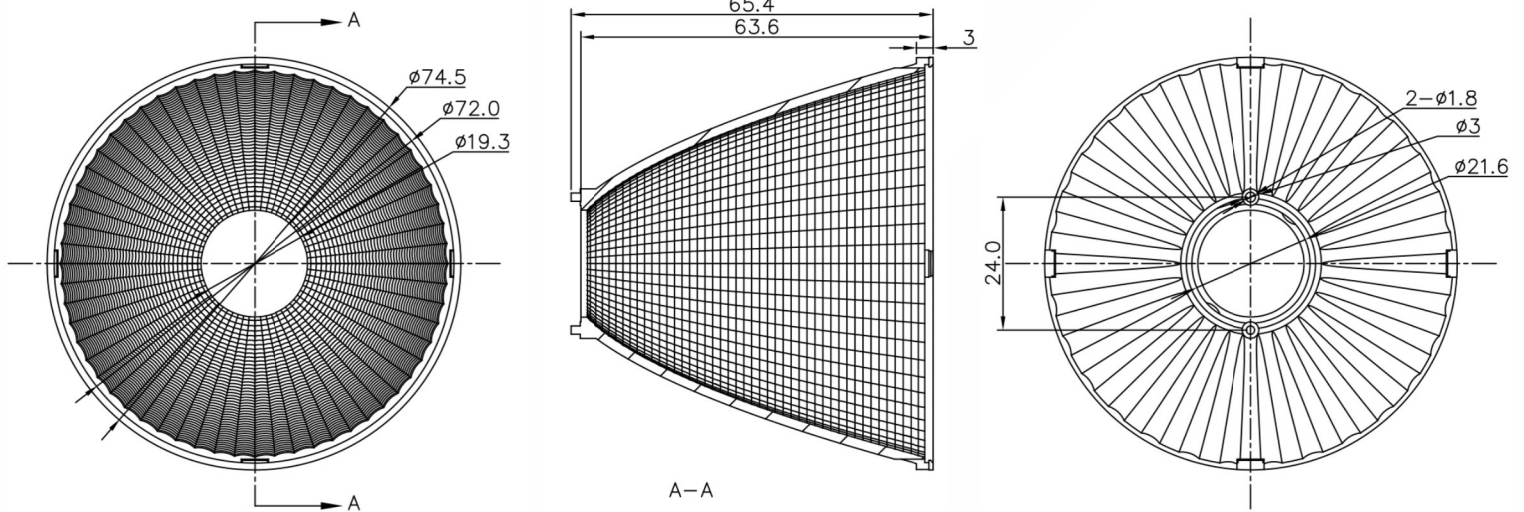
Relative intensity of QR07538

PRODUCT DIMENSION

Unit:mm



PACKING INFORMATION

Packing quantity	400pcs/10 layers / carton
Gross weight	18kgs
Carton measurement	650*400*680mm

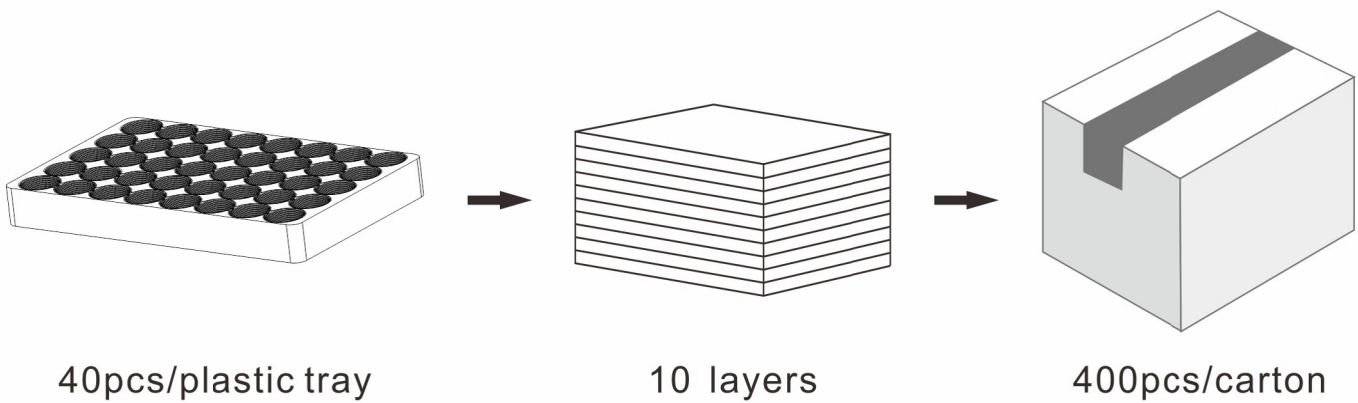

Note:

* Above measurement and weight are measured manually.
If there have any difference, please refer to the actual product.

2/F, Building C1, No.73 Weiwu Road, Zengcheng, Guangzhou, China

Tel: +86 20 8266 0966
Fax: +86 20 8264 3119

E-mail: sales@opto-source.com
Website: www.opto-source.com

