

**PRODUCT SPECIFICATION**
**R035**

Version:20191009v1



Basic parameters	-----	P2
Photometric data	-----	P3
Product dimension	-----	P4
Packing information	-----	P5

**PRODUCT EXPLAIN**

---

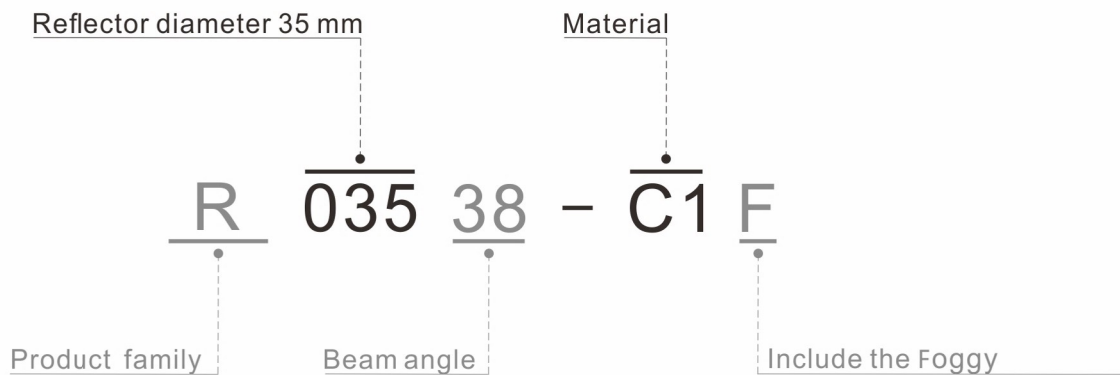

## BASIC PARAMETERS

Model	R035
Beam angle	24°/38°/56°
Cover	Foggy
Operating temperature (Tc)	≤70°C
Plating/Color	Vacuum plating/Silver
RoHS	Yes
Material	PC
Lens	No

## SOURCE

Bridgelux: E6 / E8 / E10 / V8 Gen8 / V10 Gen8 / V10 Gen7 / V10 Gen6 / V6 HD  
Vero 10 Gen6 / Vero 10 Gen7

Citizen: CLU02x-120x

Cree: CXA15xx / CXB15xx / CMA1516 / CMT14xx

Luminus: CHM-9(AC00) Gen1 / CLM-9(AC00) Gen1 / CXM-9(AC00) Gen1 / CHM-6-XH20 Gen2  
CHM-9(AC10) Gen2 / CXM-9(AC00) Gen2 / CIM-9(AC30) Gen3 / CLM-9(AC30) Gen3  
CXM-9(AC30) Gen3 / CIM-9 Gen4 / CLM-9(AC40) Gen4 / CXM-9 Gen4

Lumileds: 1202s / 1202HD

Osram: S9

Nichia: NTCWT012B / NTCWS024B / NVNWS007Z / NJCWS024Z

Samsung: LC010C / LC003D / LC006D / LC009D / LC013D

Seoul: SAWS0661A / SAWS1063A / SAW00661A / SAW01062A / SAW01063A / SAW80661A  
SAW90661A / SAW81062A SAW91062A / SAW81063A SAW91063A

Tridonic: SLE G7 9mm

## HOLDERS



BRHV068-F



BCH1020-A



BRHV068-PA



BRHV068-PD



CIHL020-A-PD



CIHL020-P

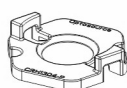

CRH1304-P

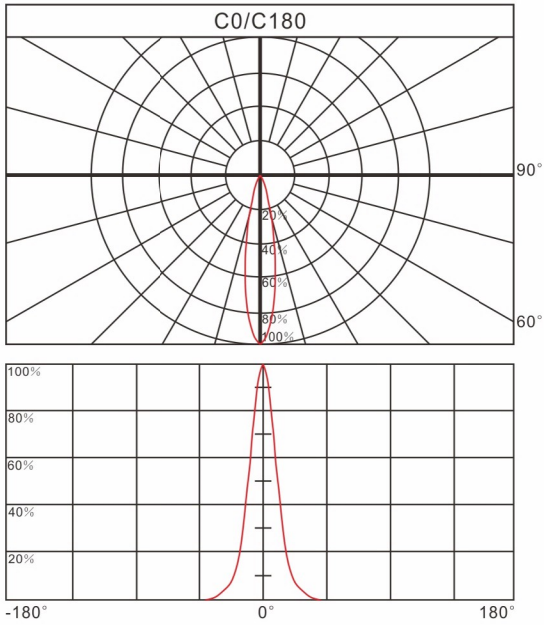
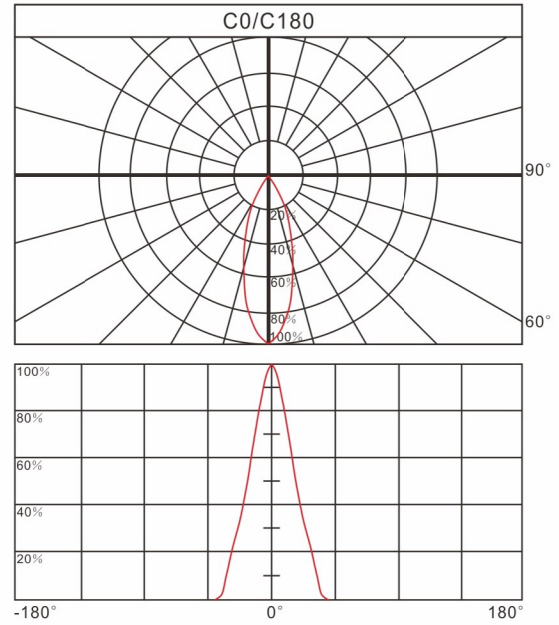
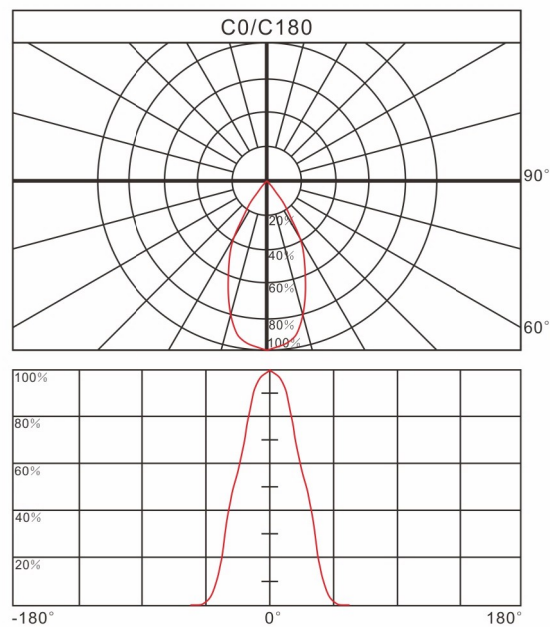

H121414E-01

**PHOTOMETRIC DATA**
**Relative intensity of R03524**

**Relative intensity of R03538**

**Relative intensity of R03556**

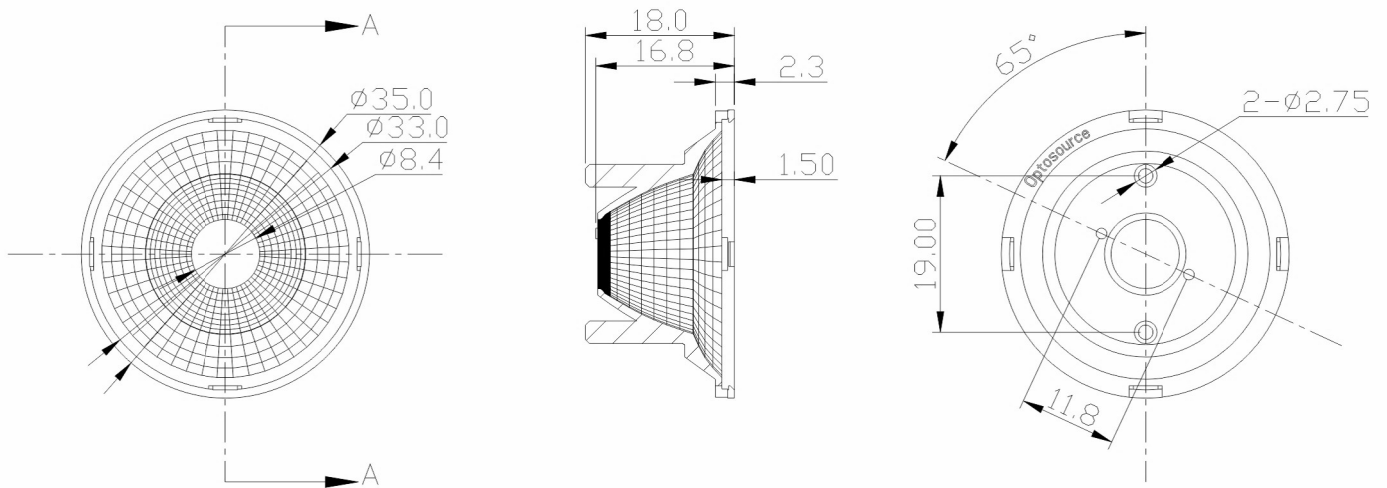
**PRODUCT DIMENSION**

Unit:mm



**PACKING INFORMATION**

Packing quantity	500pcs/10 layers / carton
Gross weight	2.1kgs
Carton measurement	515*290*270mm

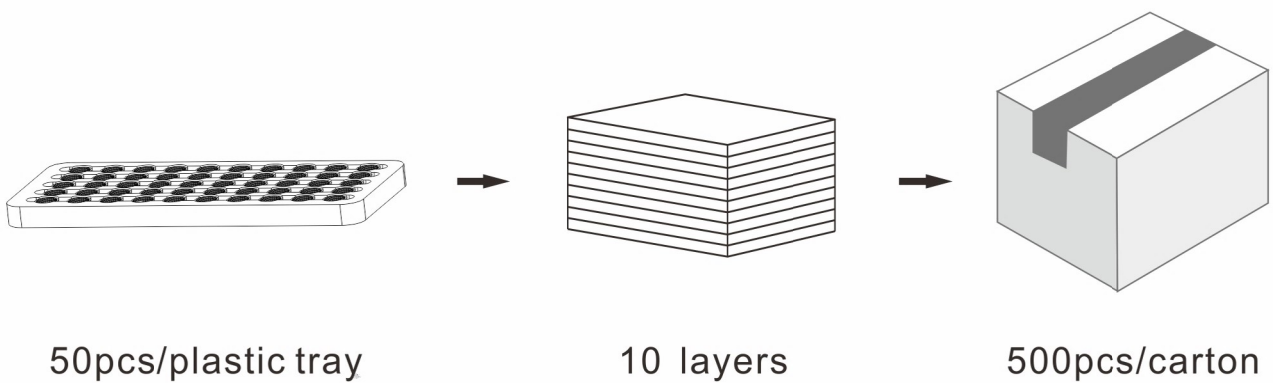

Note:

- \* Above measurement and weight are measured manually.  
If there have any difference, please refer to the actual product.

2/F, Building C1, No.73 Weiwu Road, Zengcheng, Guangzhou, China



Tel: +86 20 8266 0966  
Fax: +86 20 8264 3119

E-mail: [sales@opto-source.com](mailto:sales@opto-source.com)  
Website: [www.opto-source.com](http://www.opto-source.com)