

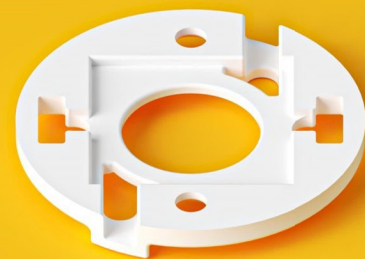

# BRHV010-P

Date:20231109 **Ver1.0**





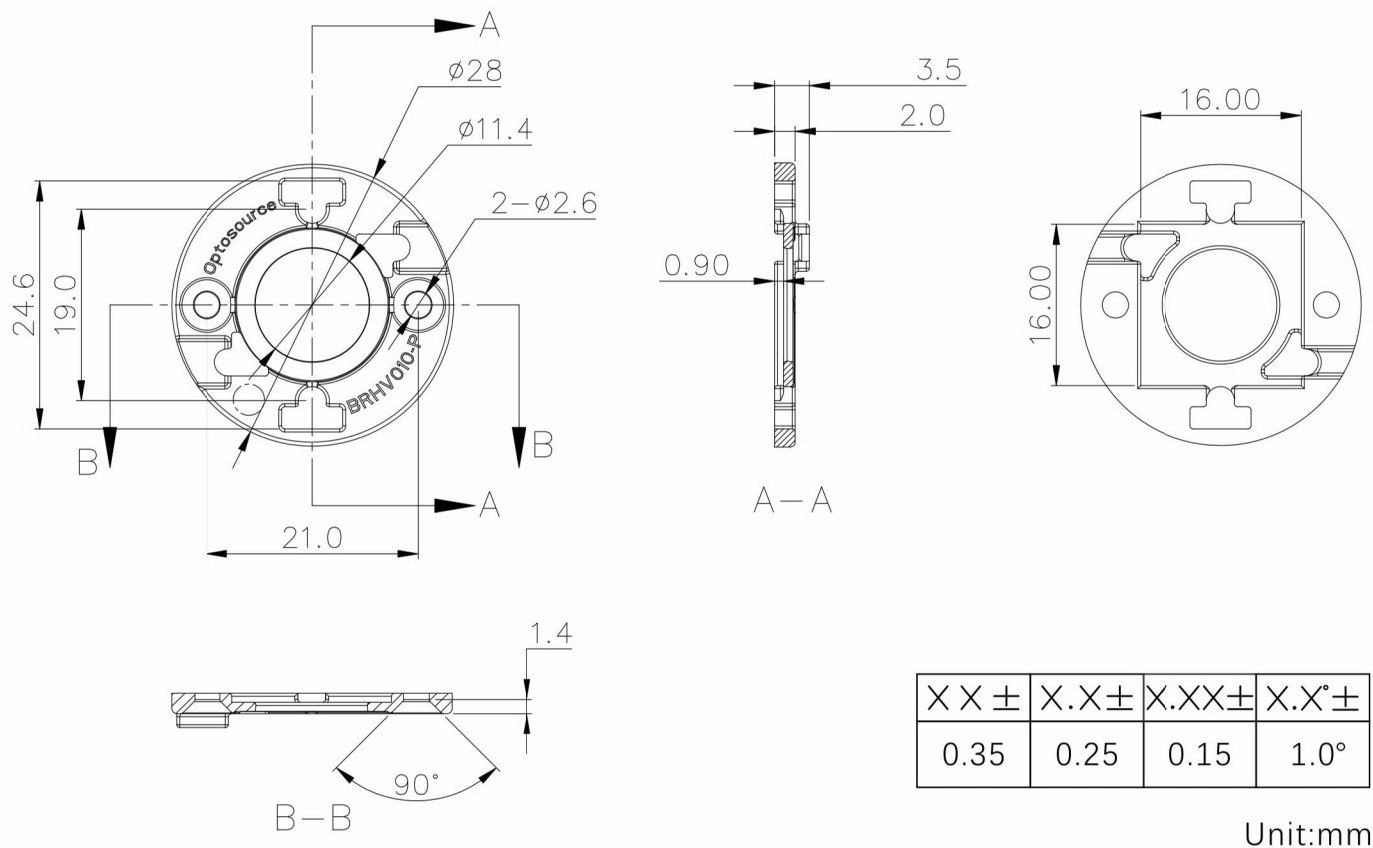

## BASIC PARAMETERS

Order code	BRHV010-P
COB dimension(mm)	15.8 * 15.8 * 1.0
Material	PC
Holder dimension(mm)	ø28 * 3.5
Operating temperature	Tj ≤ 85°C
Screw size	M3
Torque N.m	0.4~0.45 N.m
COB LES(mm)	3~12
RoHS	Yes

## DRAWING



www.opto-source.com

-  +86 20 8266 0966
-  +86 20 8264 3119
-  sales@opto-source.com
-  www.opto-source.com
-  2/F, Building C1, No.73, Weiwu Road, Zengcheng, Guangzhou, China, 511300

— Reflector — Lens — Mold

© 09/11/2023 Optosource, Inc. All rights reserved.