

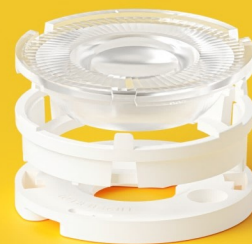

# L035A-00

Date:20231109 **Ver1.0**



## BASIC PARAMETERS

Basic parameters / Drawing ————— 1~3P

Source / Holders ————— 4P

Luminous intensity distribution curve ————— 5P

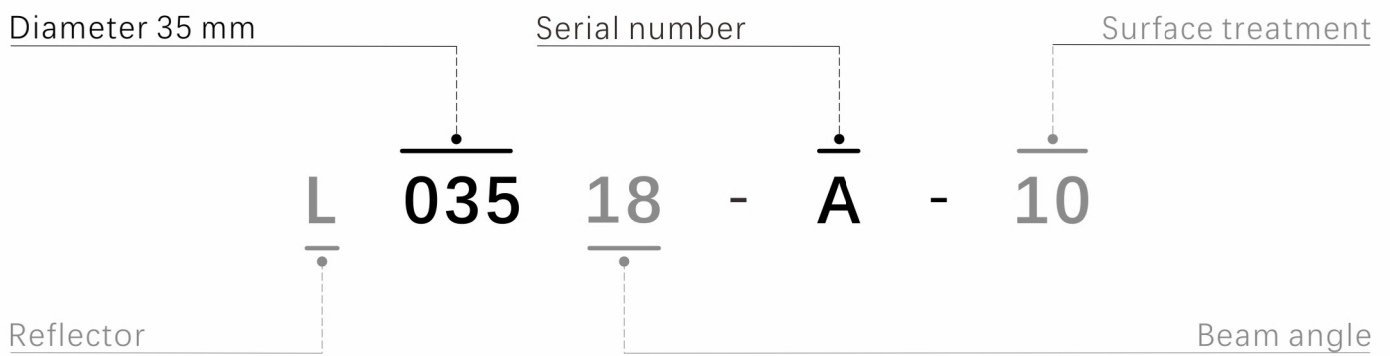

## BASIC PARAMETERS

Model	L035A-00
Beam angle	18° / 24° / 36° / 60°
Cover	No
Operating temperature	$T_c \leq 85^\circ\text{C}$
Plating / Color	Vacuum plating / Silver
RoHS	Yes
Material	PMMA
Lens	No
Efficiency	88%

## DRAWING

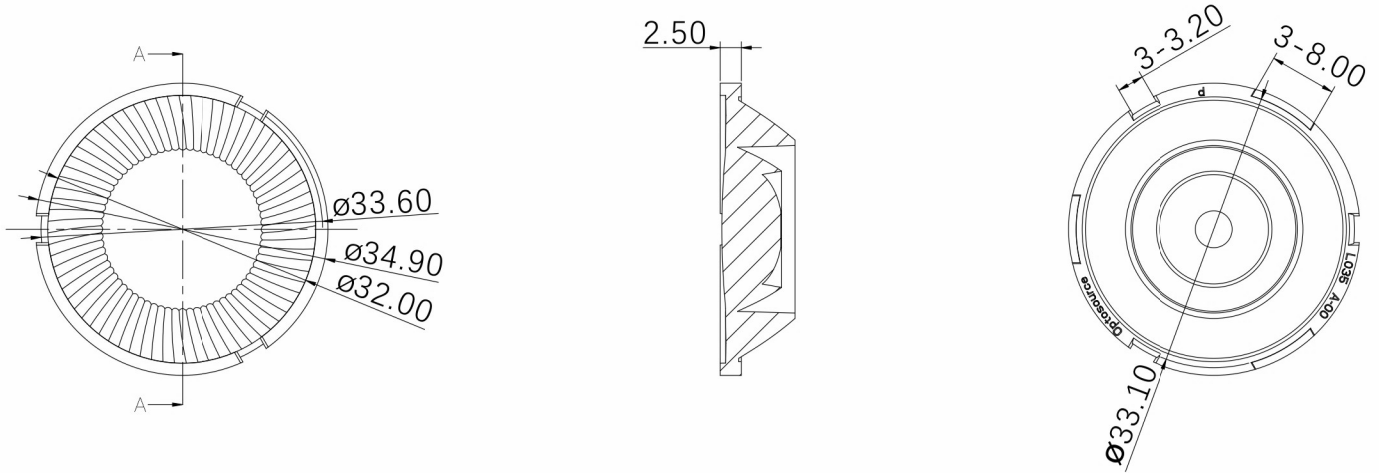

$\times \times \pm$	$\times . \times \pm$	$\times . \times \times \pm$	$\times . \times ^\circ \pm$
0.35	0.25	0.20	0.5°

Unit:mm

## SOURCE

### ■ LES 3~6mm

Bridgelux	V3 HD gen8 / V4 HD gen8
Citizen	CLU7A2 / CLU7A3
CREE	CHA0304 / CHA0410 / CHA0612
Luminus	CXM-3 Gen4 / CXM-4 Gen4 Gen6 / CHM-4-BH40 / CXM-4-TE50 LUX
Tridonic	SLE 04mm

### ■ LES 7~11mm

Bridgelux	V6 HD Gen7 gen8 / V10-gen7 gen8 gen9 / E10
Citizen	CLU028 / CLU02J / CLU02Q / CLU703 / CLU702 / CLU701
CREE	CHA0825 / CMT1407 / CMT1420 / CMU1003 / CMU1013
Lumens	1309H2 / 1318H2
Lumileds	L02x06 / L04x09
Luminus	CXM-6-AC30 gen3 / CXM-6 gen4 / CXM-6 gen6 / CHM-6-BH40 / CXM-6 LUX / CHM-9 gen3 CIM-9 gen4 / CIM-9 gen3 / CLM-9-AC30 gen3 / CLM-9-AC40 gen4 / CXM-9-AC40 gen4 CLM-9 gen6 / CXM-9-TC60 gen6 / CLM-9-TC50 Lux
Osram	S9
Samsung	LC010C / LC003D / LC006D / LC009D / LC013D
Seoul	SAWS0661A / SAWS1063A
Tridonic	SLE 06mm / SLE 09mm / SLE G7 09mm

## HOLDERS

Type	COB size(mm)	COB LES(mm)	Size(mm)	Material	Screw size
TRH0023-P	31×31	20~27	ø46×3.5	PC	M3

# LUMINOUS INTENSITY DISTRIBUTION CURVE

## Relative intensity of L03518A-00

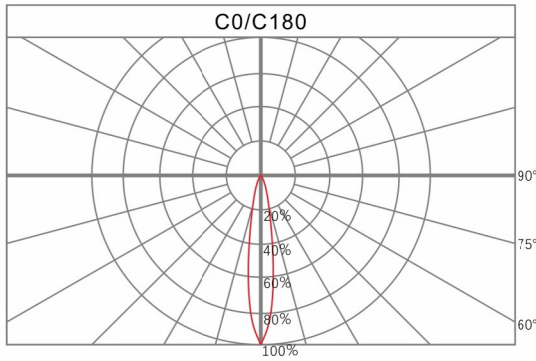

## Relative intensity of L03524A-00

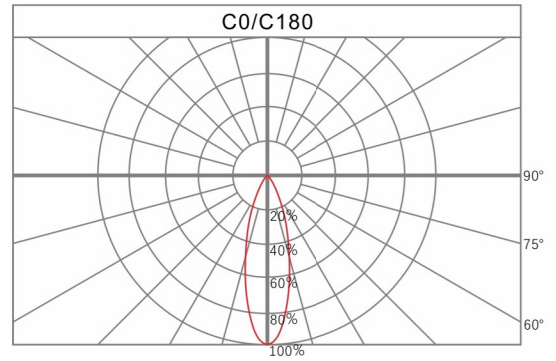

## Relative intensity of L03536A-00

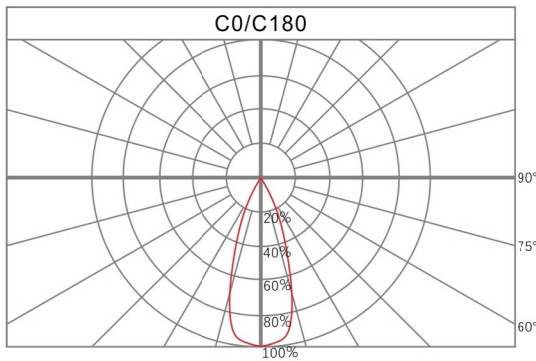

## Relative intensity of L03560A-00

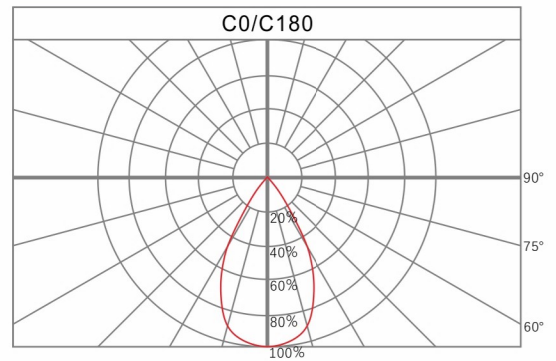

www.opto-source.com



+86 20 8266 0966



+86 18820021222



amyzou@hkoptosource.com



www.opto-source.com



广州市增城经济技术开发区香山大道42号雄兴孵化园4栋

Building 4, Xiongxing Incubation Park, No.42 Xiangshan Avenue,  
Zengcheng Economic and Technological Development Zone, Guangzhou, China